

# CRoom Control

CR0.9/ CR1.2/ CR1.5/ CR1.9





- Power and receiving card redundancy
- Heat dissipation & circuit layout
- Electromagnetic compatibility and protection
- More efficient, secure and reliable power box
- Built to last

## Security and Stability

# 02



## 03 Simple Installation and Maintenance

- *TotalPlug* wireless technology
- *PreciseAlign* technology
- Simple rear maintenance
- Calibration technology

# 01



## Professional Display

- *CrystalView* professional image processing technology
- 16:9 HD & 4K pixel-to-pixel resolution
- High contrast ratio
- Extended viewing angles
- True colors
- A3C+ third-generation calibration technology

# 04



## Turn Key Solution

- General accessories
- Studio-specific accessories
- Broadcasting platform
- System topology
- Command center
- Dispatching center
- Smart city

# CR Series



CrystalView  
technology



16:9 HD & 4K  
pixel-to-pixel  
resolution



Power & data  
redundancy



Simple  
maintenance

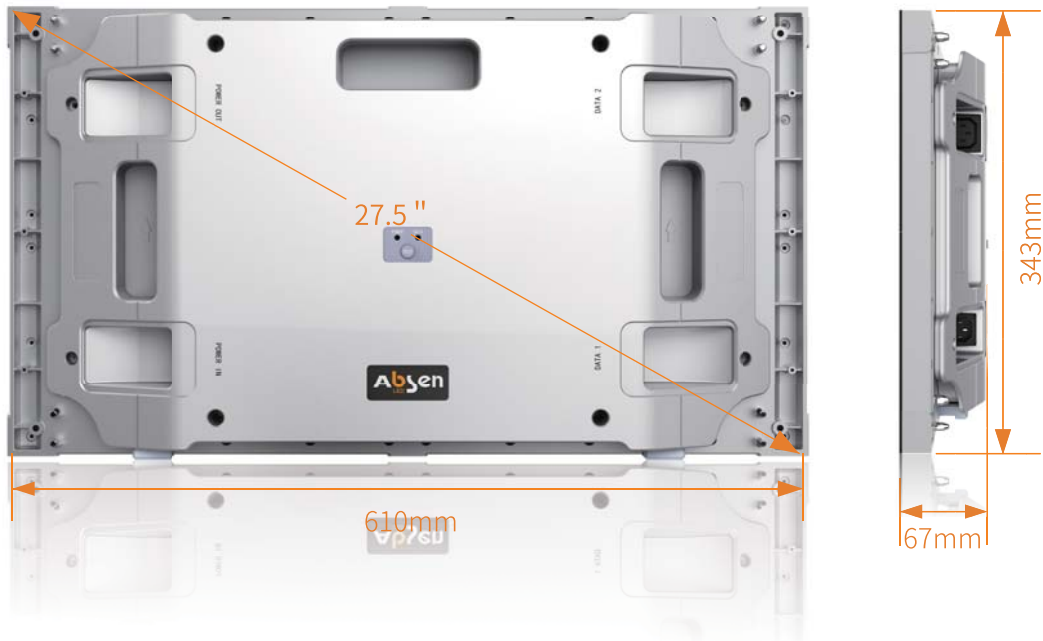



# Professional Display



CrystalView uses Scrambled-PWM (S-PWM) technology to enhance the modulation on the pulse width and splits the turn-on time into several shorter ones, thus increasing the visual refresh rate. In addition, CrystalView multiplies the GCLK frequency effectively improving the GCLK frequency to double its visual refresh rate.

## ▶ High grayscale at low brightness levels

An LED can display more detail with more vivid images and richer color than a normal LCD. This is because LED display can enrich the color layering to enhance the details. But traditionally even on LED as one decreased the brightness the greyscale also decreased leaving images flat at low brightness levels. The CR series uses a premium SRAM chip which can maintain complete detail and high contrast ratio while achieving high greyscale even at low brightness levels. This allows a natural and smooth color gradient and superior image accuracy at almost any brightness setting and room condition. So, no matter the location, the CR series will always look outstanding!



Details lost in the shadows



Details still visible in the shadows

As variation of grey occurs on an image, tradition chips can struggle to create a smooth transition between color variation. The new CrystalView chip processes this variation smoothly so the shift in color is lifelike and without visual stutter.



Poor transition of grayscale



Smooth transition of grayscale in the CR series

## ▶ Ultra-High refresh rate

Backed by the Scrambled-PWM (S-PWM) technology, the *CrystalView* technology implements enhanced modulation on the pulse width and splits the turn-on time into several shorter ones, thus increasing the visual refresh rate of displays. In addition, the GCLK frequency multiplication technology effectively improves the GCLK frequency to double its visual refresh rate.



Slow response to moving objects, blurring images



Quick response to moving objects, clear images



Low refresh rate



High refresh rate

## ▶ Sharper images

*CrystalView* greatly improves the performance of details and sharpness in the shadows of images. This extra sharpness helps not only in low brightness conditions but also with gradients, dark lines, high contrast interference and ghosting.



Before sharpening



After sharpening

Image sharpening also enhances the contrast of the gray scale to make blurred images clearer. It can also help decrease the ghosting effect that can happen on text. This ghosting can make letter edges appear blurry. The CR series can use its sharpening to improve details at the edge of objects so that the edges, outlines and image details are all clear.



Before processing



After processing

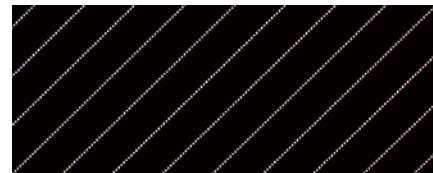

## ▶ Enhanced colors

By handling the white balance and color cast at low gray scale, the tone of the entire image deviates from the original color, so that the image can loyally display the material color to improve visual effects and image definition. On the other side, if colors in the area with low brightness are affected by the area with high brightness and consequently the colors in images with low brightness change due to images with high brightness, the CR series can take countermeasures to eliminate the high-contrast interference.



Display effect at low gray scale,  
with color lumps and dead brightness zone



Display effect at high gray scale,  
with natural color transition.

When dead pixels do occur the CR series can weaken the area crossing the dead pixel to reduce the defect on a displayed image and increase the look of the image until that module can be replaced.

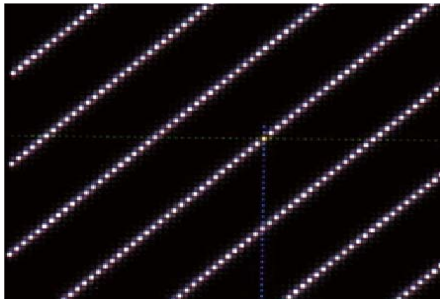

Before processing

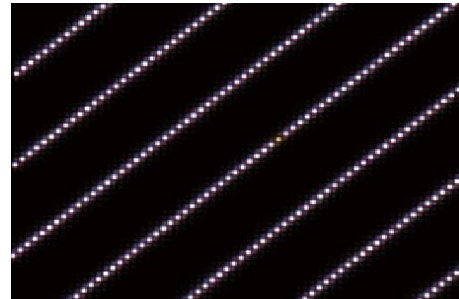

After processing





## 16:9 HD & 4K Pixel-to-Pixel Resolution

The 27.5" diagonal CR panel is made to create 16:9 resolution screens. This means that it can make true pixel to pixel HD, 4K and even 8K solutions. This means that true HD and 4K media can be shown on the screen without scaling to fit the screen. The closer the image is to its native format the better it will look on the screen without any distortion to image quality.

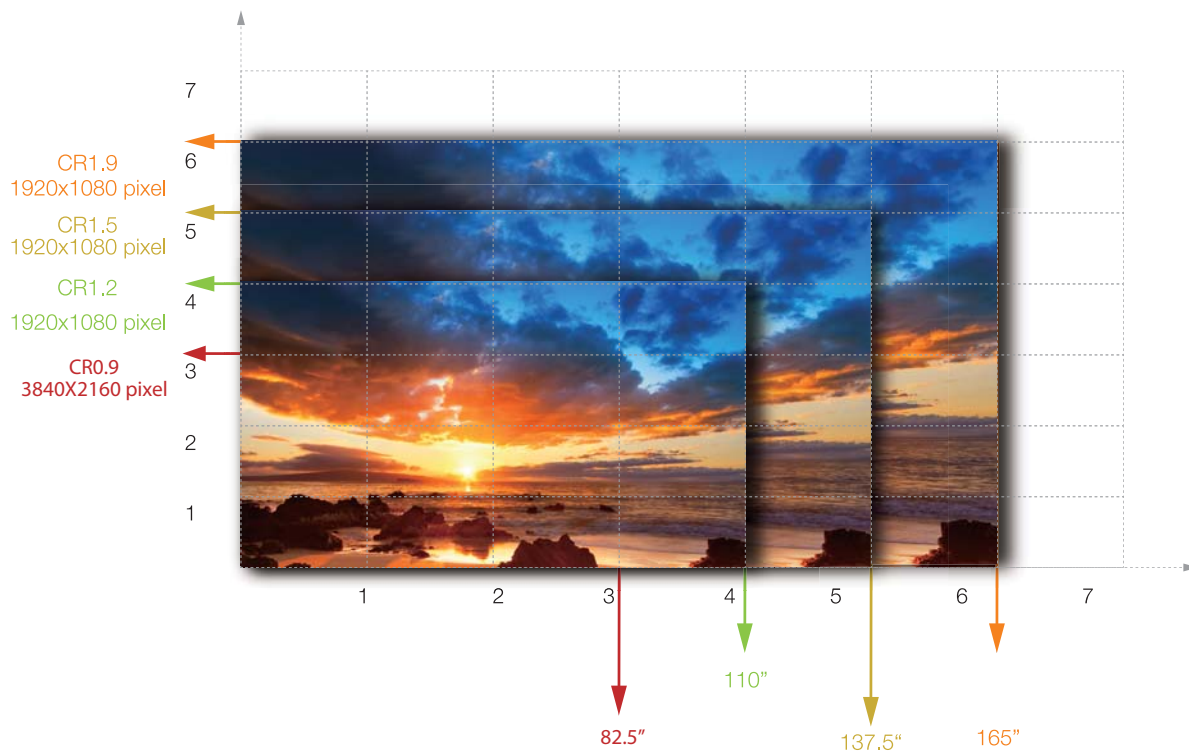



## High Contrast Ratio

---

The CR series adopts multiple industry-leading techniques to get the highest possible contrast from the screen. The black encapsulation SMDs mean that the black levels will be truer and deeper than anything found in LCD. This is enhanced further with a true black mask that gives a rich black whenever there is black content on the screen. Finally a non-reflective coating is included to ensure that these dark black contrasts are not showing ambient light sources on the screen. The result is a super high contrast with amazing black levels that bring content to life in true color.

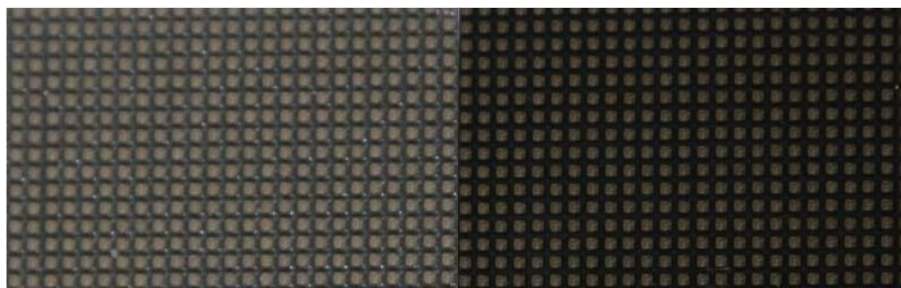

Without the mask

With the matte black mask



Low contrast ratio



High contrast ratio



## Extended Viewing Angles

The CR series have a wide viewing angle of 160°/140°. Images are clear and even when viewing images from even extreme side angles or from above or below the screen. Get the message on the screen out to the widest audience possible and make sure that they are seeing that content as intended without traditional LCD angle fade, color lumps, or mosaics.

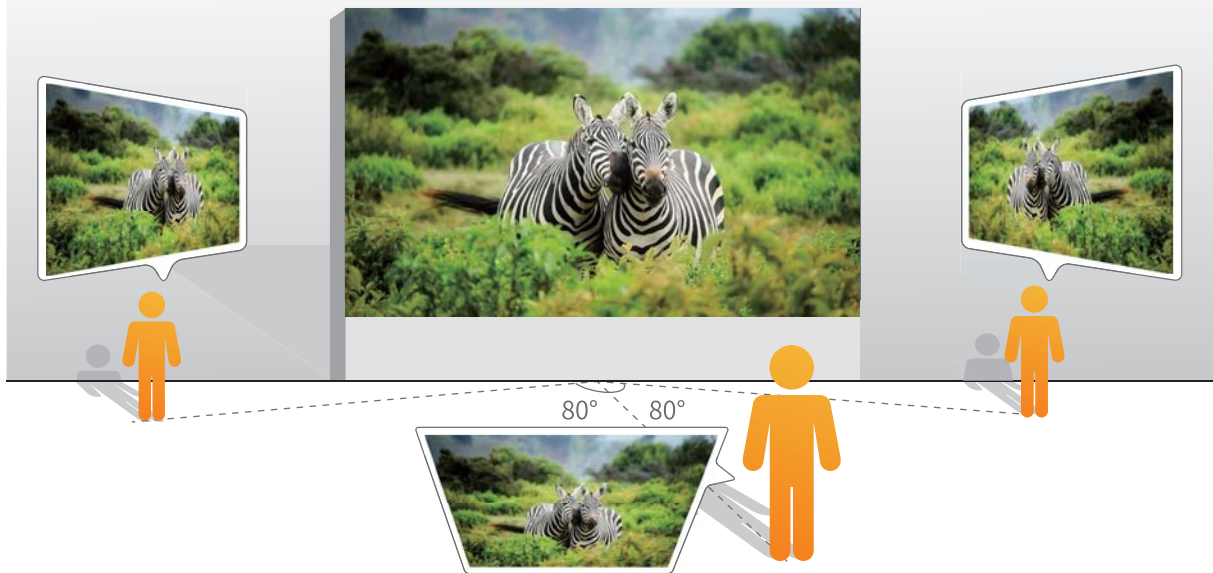

With the mask lower than the light emitting surface the viewing angle can be increased while still protecting the diode.





## True Colors

The CR series provides color at 110% the broadcast-level NTSC color gamut. This far exceeds the number of colors displayed on most by LCD screens. This leap in color quality accurately restores the rich colors found in nature to the screen. This helps to create an image that pops off the screen while looking incredibly true to life.



LCD



CR series

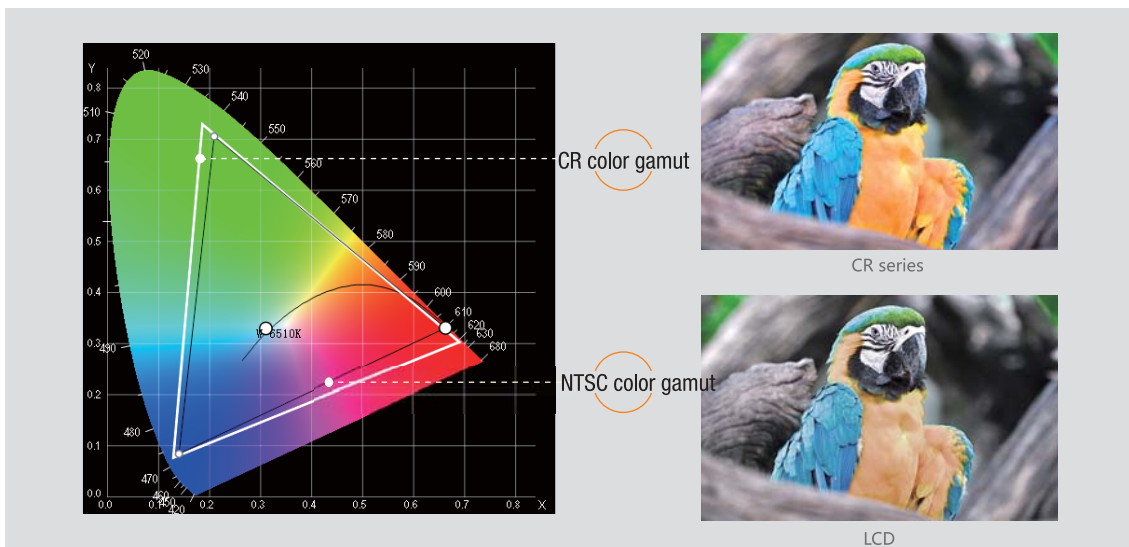

The CR series display has a wide color gamut and rich colors; The LCD screen has a narrow color gamut and dim colors.



## A3C+ Third-Generation Calibration Technology

A3C+: Absen 3<sup>rd</sup> Generation Calibration with Auto-Upload Feature.

The A3C technology enables modules to store calibration data, while the upgraded A3C+ allows modules to automatically and directly import calibration data during module replacement, which involves no manual data update and ensures even brightness and chromaticity of the screen.

Pixel-level calibration is performed before delivery to ensure best consistency of the images.

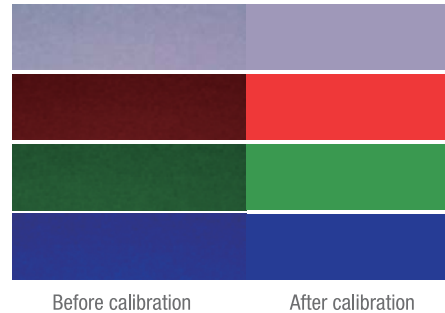

The color temperature is adjustable between 3000K to 9500K to adapt to different environments.

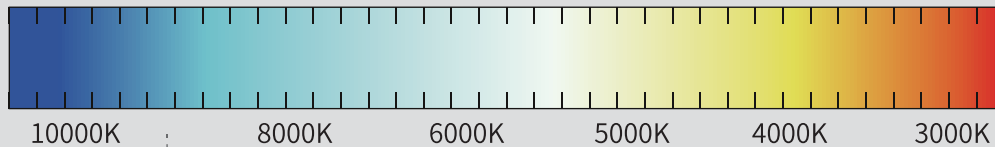



## Higher Brightness and Contrast Ratio<sup>(CR0.9)</sup>

- CR0.9 product use four-in-one IMD(Integrated Mounted LED) : Four sets of RGB are packaged on one substrate according to the set array.
- Standing for the high brightness black, absen HBB utilises Absen Common Cathode technology, a powerful solution for driving high resolution black LED at ultra high brightness.

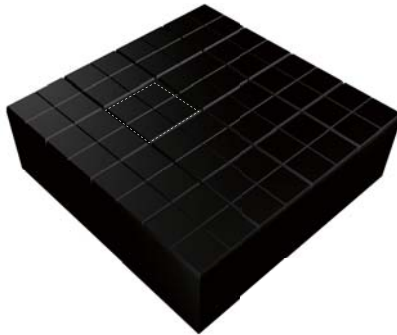

Crossing Design

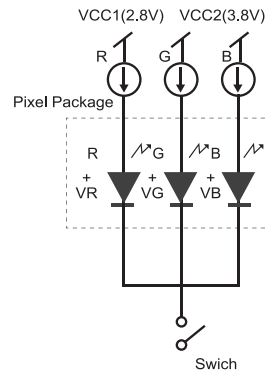

- ✓ RGB separate power supply
- ✓ No external resistors
- ✓ High precision voltage control
- ✓ Low heat dissipation
- ✓ Lower power consumption
- ✓ Higher LED lifespan and uniformity
- ✓ Lower colour shift at low brightness
- ✓ Lower pixel and circuit failure

Absen HBB Common Cathode

The image display has higher brightness and contrast ratio



Low contrast ratio



High contrast ratio



# Security and Stability



## Power & Data Redundancy

Control rooms displays require as many redundancies as possible to ensure that the screen never goes down at an important moment. To meet this need the CR series can be equipped with two power banks and two receiving cards per panel ensuring that whenever one does fail there will always be a failsafe ensuring continued performance until the faulty equipment can be replaced.

**Dual Power:** Two power boxes can be installed in each panel and work together with shared current. When one of the power boxes fails, the other ensures normal and stable operations.

**Dual Receiving Cards:** Two receiving cards can be installed with two input and two output interfaces on the panel for signal backup. When one receiving card is faulty, the other one starts to work to ensure uninterrupted signals.

In addition the entire data loop can be connected to controllers on both sides (since data runs both ways). When transmission fails on master signal channel A, backup signal channel B automatically switches to transmission from the last panel for loop backup of signals. This gives 4 complete data redundancies to ensure the signal does not go down.

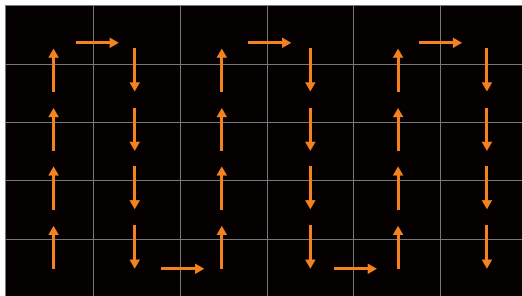

Signal input

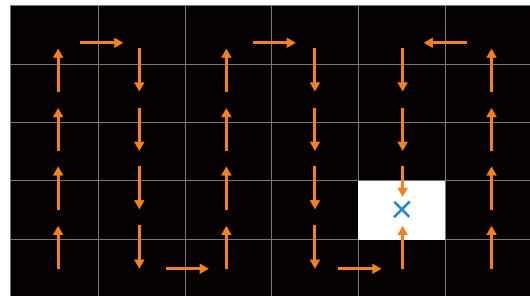

Signal input





## Heat Dissipation & Circuit Layout

The circuit layout provides good heat dissipation by arranging the electronic components and heat conductive materials in a way on the PCB board to prevent components that dissipate too much heat from being too close on one corner of the board. This reduces temperature difference on each part of the card so that color cast will not occur on the screen due to uneven temperatures. This effectively extends the product life and achieves more stable effect and a better-looking display.

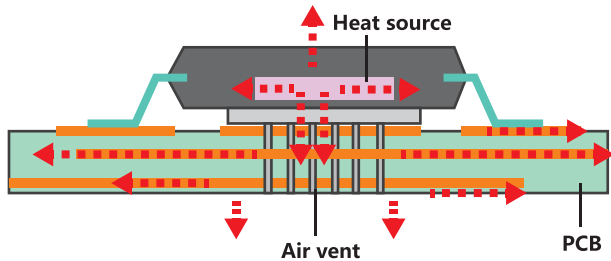

## Electromagnetic Compatibility and Protection

The CR series have passed the 3C/CE/ETL/FCC/RoHS certification and met electromagnetic compatibility requirements. It can effectively shield externally radiated electromagnetic waves to prevent other equipment in the environment from being affected by its electromagnetic interference. Meanwhile, products are equipped with ultra-strong anti-interference capabilities to prevent errors under external electromagnetic interference.

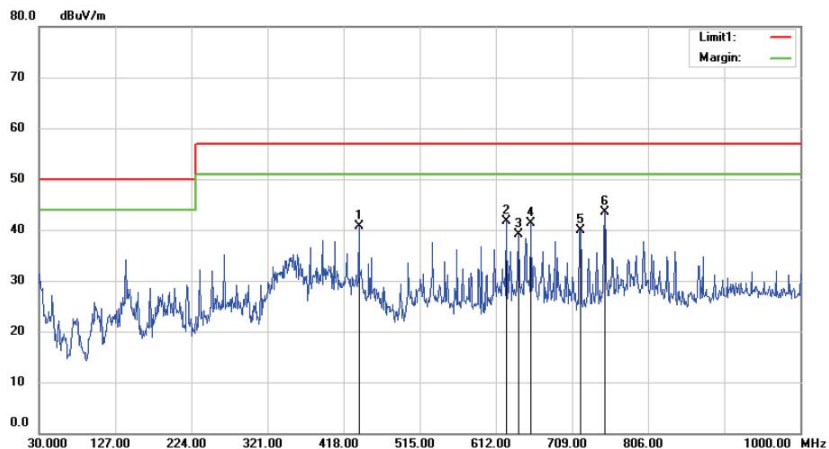



## More Efficient, Secure and Reliable Power Box

The CR series uses power boxes with above 90% conversion efficiency. These upgraded power boxes reduce generated heat and relieve dissipation efforts with reduced power consumption. The power box is equipped with PFC functions to reduce idling as well as interference from harmonic waves on the power box.

Voltage, current, and short-circuit protection are configured. Power recovers automatically upon short circuits. Overheating controls are also in place. Once the temperature exceeds the threshold, the power is cut off protecting the power and the screen until the heat is reduced at which time the power box is completely recoverable.



## Built to Last

The service life of the LED screen is determined by the product design, manufacturing process, and quality management. The CR series are built to last with good heat dissipation, strong moisture-proof capability, and are very reliable.

All our LED panels go through multiple tests including thermal shock, temperature, humidity, vibration, and salt spray tests, to prove their strength, reliability and durability. The CR series passes all of these tests with flying colors to become one of the most rugged and long-lasting products available.



### Thermal shock test

Temperature cycle of -20°C to 50°C



### Constant temperature and humidity test

Temperature rise of 50°C



## High reliability & easy maintainability (CR0.9)

Comparing to copper skin of the ordinary LED is same size with pad, copper skin of the four-in-one LED is larger than pad.

- Bonding is more solid and reliable, greatly reducing the probability of knocking out LED
- PCB pad is large enough and fewer numbers for easy maintenance

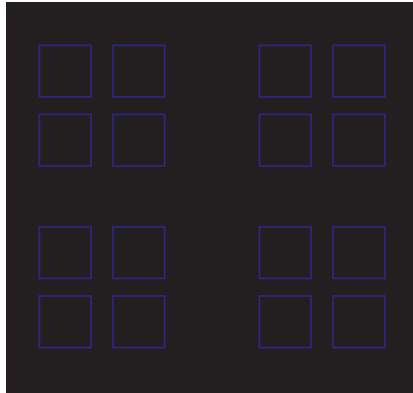

Copper skin of ordinary LED  
16X0.35\*0.35 mm

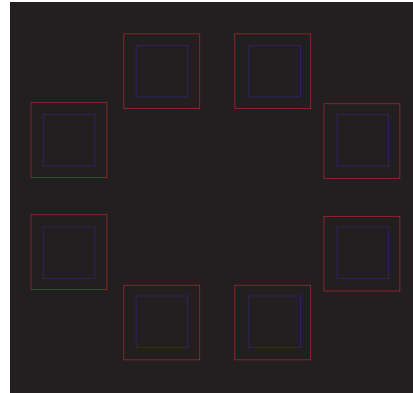

Copper skin of the four-in-one LED  
8X0.5\*0.5 mm



# Simple Installation & Maintenance



**CNC die casting aluminum panel**

The aluminum alloy is strong and dense. It is durable, has anti-corrosive properties and is not prone to deformation under external force. The CR series aluminum alloy frame can also withstand high temperatures, provides good thermal conductivity and can effectively dissipate heat.

**Power interface**

Plug-n-play power that can be replaced without tools.

**Central handle**

**Locating pin**

**16 micro screw holes**

**Left and right grippers**

**Test button**

**Network cable port**

Plug-n-play receiving card that can be replaced without removing cables.

**Screw holes for yellow spot alignment**

**Connection plate**

Adjustable connection plate between panels to ensure flatness and uniformity between panels.





## TotalPlug Wireless Technology

Designed with air circulation in mind, the panel has convection holes for quick internal heat dissipation to ensure stability and performance. The aluminum alloy structure also directly dissipates heat evenly ensuring product reliability. Even heat and dissipation will ensure the LEDs age correctly and extend the life of the LEDs and the panel.

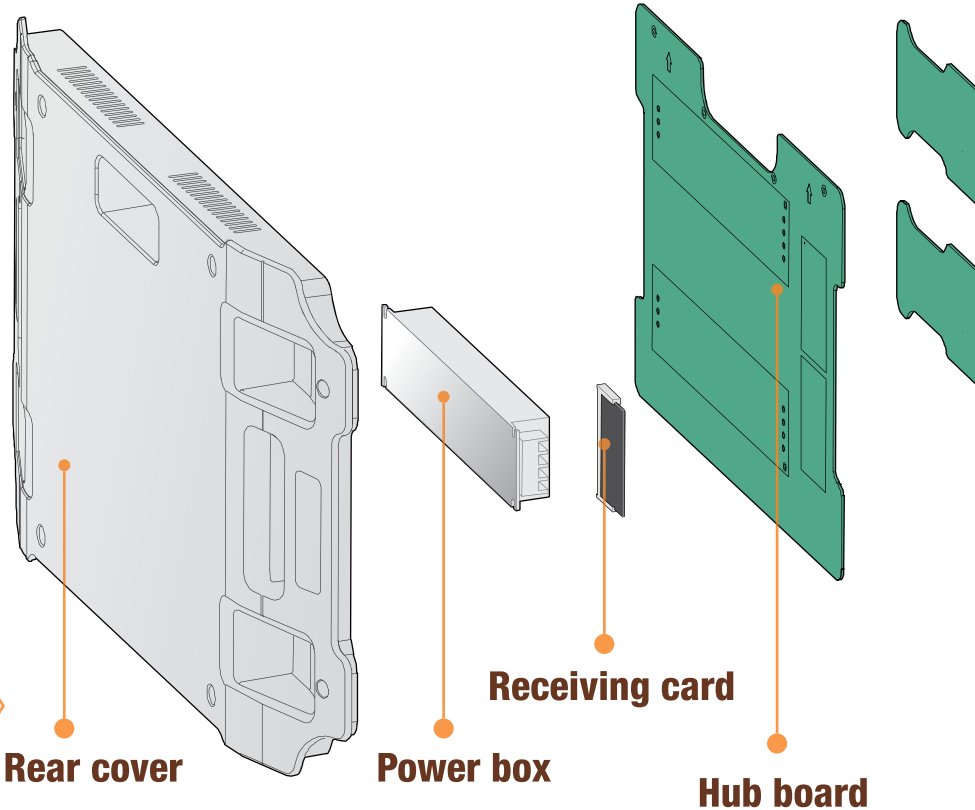

With integrated molding, the module uses a non-plastic bottom case design, and the light board clings to the aluminum alloy panel. All components are directly inserted into the casing and combined to provide better heat dissipation and to achieve a flatter and more uniform screen.



**Panel**

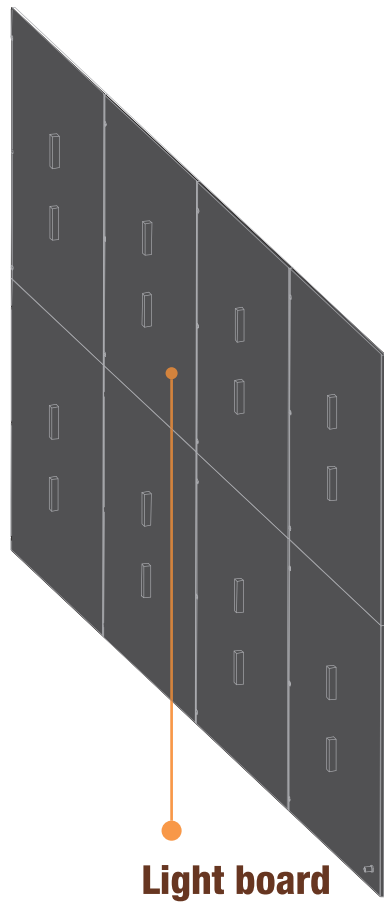
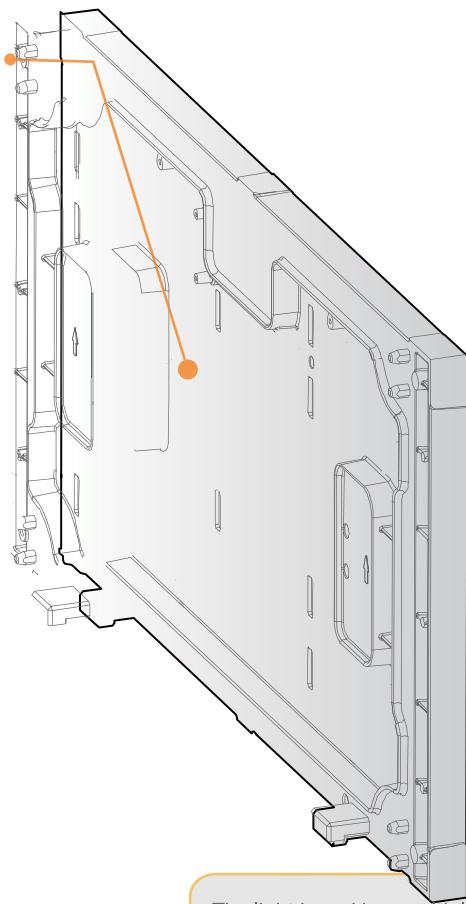

**Light board**



**Adapter plate**

The light board has multiple grounding points, not only fixing the components but also reducing electromagnetic radiation. The PCBA uses a large welding pad to effectively enhance the adhesion and secure the LED light. The welding pad is treated by the immersion gold process. Nickel-gold is welded to the tin to protect the copper sheet on the welding pad from being oxidized or corroded, thus protecting the PCB from oxidation of the PCB. This is a lead-free process, which is environmental-friendly and meets the RoHS standard.



## **PreciseAlign Technology**

The LED panel has seam adjustments in two directions on the Z axis. When the LED units are connected, fine tuning eliminates seams, reduces bright and dark lines that may appear on the screen and eases installation speed.

In addition to the physical fine tuning of seams, an additional software option offers one-click seam brightness adjustment to create a truly awesome bezel and gap free full screen appearance.

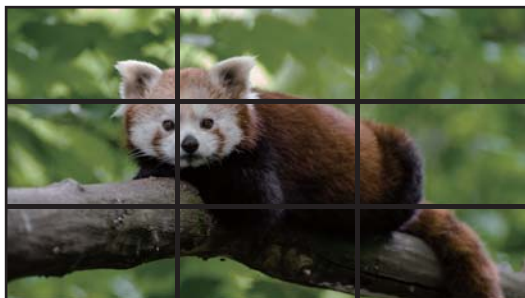

LCD splicing



LED splicing

Adjustable Z-axis  
in two directions



Screw holes for fine-tuning



Connection plate





## Simple Rear Maintenance

---

The power and receiving cards adopt the pluggable design and can be replaced without tools, which facilitates maintenance.

External indicators/test buttons are provided for convenient inspections.

Small modules can be replaced, reducing the maintenance costs.



## Calibration Technology

---

The CR series provide the smart positioning panel for quick installation, commissioning and maintenance.

The CR series support sequencing during installation and commissioning and calibration upon failures. The sequence can be set in the system for automatic identification and display of network cable connection sequences. Smart installation and commissioning is implemented, facilitating quick relationship establishment and preventing the tedious work brought by the manual network cable check.

## ► Installation Sequencing

The CR series can automatically identify the network cable connection sequence, which is displayed on the panel in digits. In this way, operators do not have to check the connections of network cables and the number of controlled cabinets before quick screen connection.

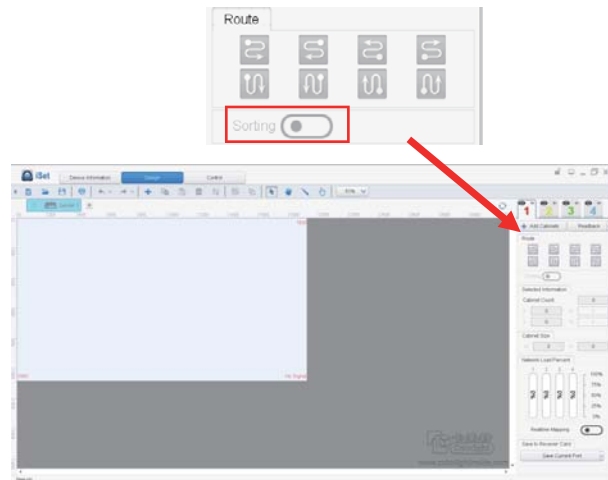
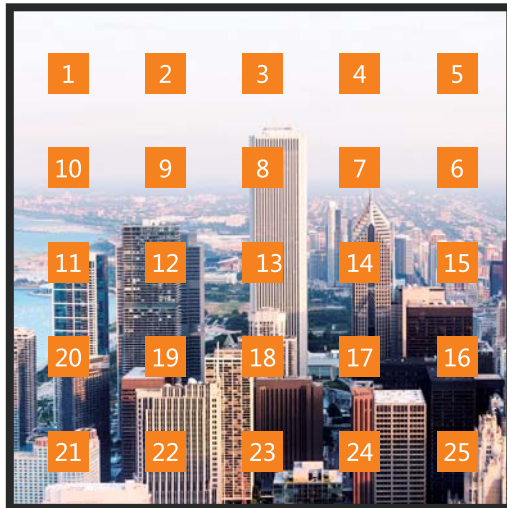

## ► Failure Calibration

When assembling or disassembling modules of the CR series, operators can configure the software so that the red, green, blue and white colors are displayed alternatively in front of the faulty panel, and the blinking frequency of the indicator at the back of the faulty panel is also different from those of other cabinets. In this way, the fault can be quickly located.

# Turn Key Solutions

南京公安  
Command Center of the Nanjing

南浦  
長江  
MI

8M



## General Accessories

**Sending box (mandatory):** It is used to send display signals. The sending box supports the HDMI and DVI video signal inputs and HDMI signal loop output, as well as DVI/HDMI signal switchover. Quick controls can be performed on the front panel. 2K and 4K sending boxes are available and are selected based on the screen size.



**Video processor (optional):** It provides multi-channel signal input interfaces. Any signal can be selected to be output to the screen or processed by relevant image processing technology. This video processor has multiple transition effects, such as fade-in and fade-out, and instance transition. The output resolution can be set based on the actual size of the LED screen for pixel-to-pixel display. The intelligent seamless splicing technology allows image splicing with unique synchronization technology to ensure smooth images of objects moving at a high speed without dislocation or ghosting. The video processor is applicable to scenarios such as conferences, activities and exhibitions and used to control screens with a resolution less than 4K.



**Splicer (optional):** It is used to control ultra-large screens with ultra-large resolutions. An ultra-large screen can be divided into multiple parts, which jointly display a complete image. Besides, the splicer supports picture in picture and picture overlapping. It supports seamless splicing of output from multiple screens and adopts the RGB 24 bits/60Hz processing internally to ensure high signal resolution and clear and smooth pictures without delays. The splicer also supports seamless splicing of multiple screens and multiple windows for applications in such fields as the command center, security monitoring and exhibition and display. The splicer supports input from multiple signal sources, such as AV, DVI, VGA, HDMI, SDI and DP. The output resolution can be self-defined to adapt to LED screens of different resolutions for pixel-to-pixel splicing display and splicing of LED screens with different pitches.



## Cable

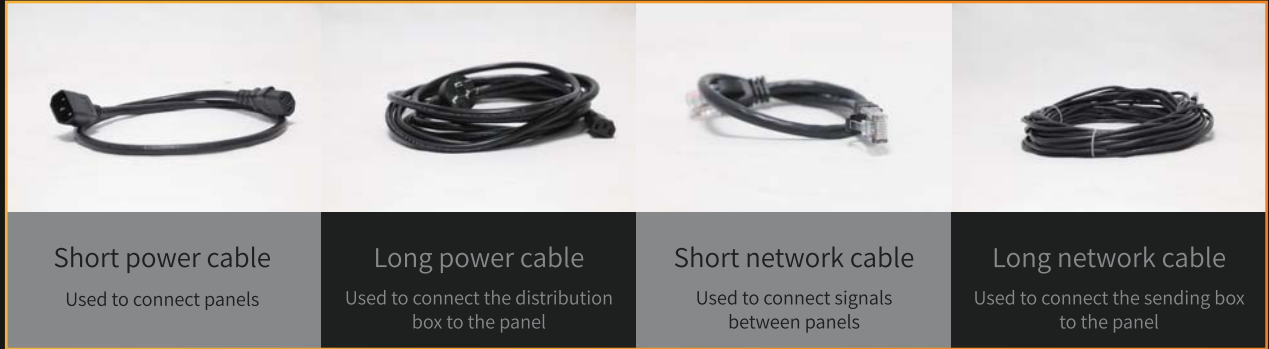

## Optional: two power boxes and two receiving cards

The dual-power and dual-receiving card can be selected based on the application scenario.

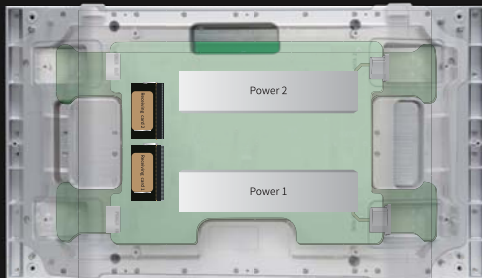

## 90° vertical splicing (customized panel and connection piece)

The cutting angle between the CR panel and module can be customized for 90° vertical installation with the splicing seam of less than 5 mm.

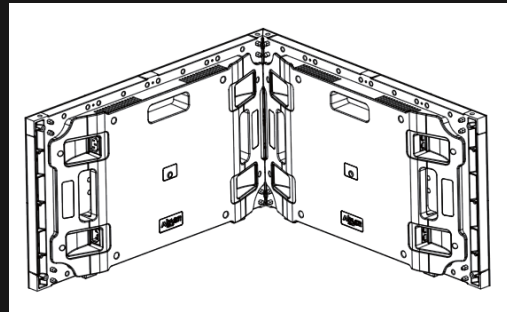



## Studio-Specific Accessories

### ► Change in Optical Gaps to Easily Eliminate Moire

Moire is the high-frequency interference occurred on the sensors of digital cameras or video recorders. It is a manifestation of the beat principle. The LED screen consists of consistently arranged dot-matrix LEDs. A large area on the entire screen is not lightened, forming a grid-like pattern, which is similar to the left picture below. When two images overlap, moire similar to the right picture below is formed.

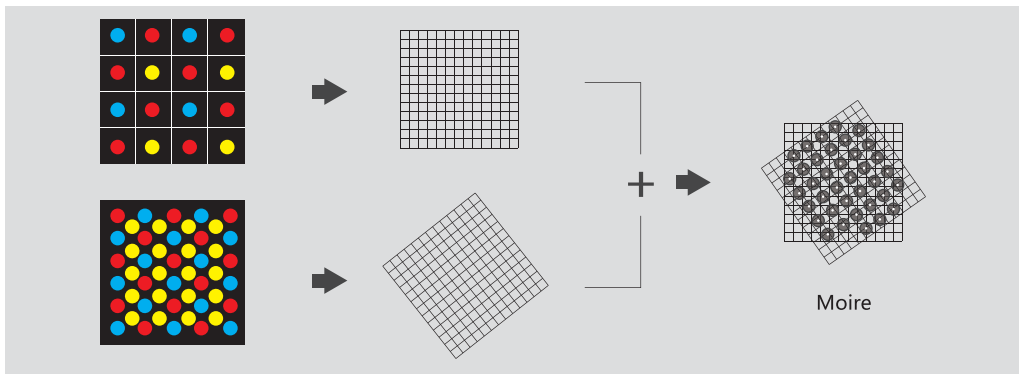

When the lens of the camera aligns to the LED screen, Moire may appear sometimes, which affects the recording effects in the studio. Moire can be reduced or eliminated by changing the angle, location, and focus of the camera, or by special technical processing on the screen. The CR series provide a complete set of solutions to eliminate Moire. The multi-layer optical structure and micron optical filtering crystals are used to guide lights and refract scattered light so that the optical gaps between LED lights are changed. In this way, Moire in the camera images is effectively eliminated. Both dynamic and static images can keep their true colors with good consistency. This not only improves color resolution of the LED wall, but also prevents the studio from being affected by Moire, greatly improving visual effects.



Images without Moire

Images with Moire

## | Broadcasting Platform

The CR series digital video broadcasting platform is a multi-service video integration platform developed for video displays used in the multi-service command/dispatch centers. Backed by advantageous resources, Absen integrates video display system applications to provide a complete system solution, meeting practical requirements of command/dispatch centers and enhancing the image display efficiency of the traditional command/dispatch centers. The platform supports hybrid input functions such as analog/digital, HD/SD, IP video streaming, and provides functions such as video access, video storage, real-time browsing, preview and review, user authentication, TV wall splicing management, device management, central control management, log management, alarm management, ultra-high GIS pushing, and visual applications. Besides, it has advanced technologies, stable performance, good compatibility, and easy operations to be applied to video display systems of large and medium command/dispatch centers in such fields as public security, transportation, power, energy and buildings.

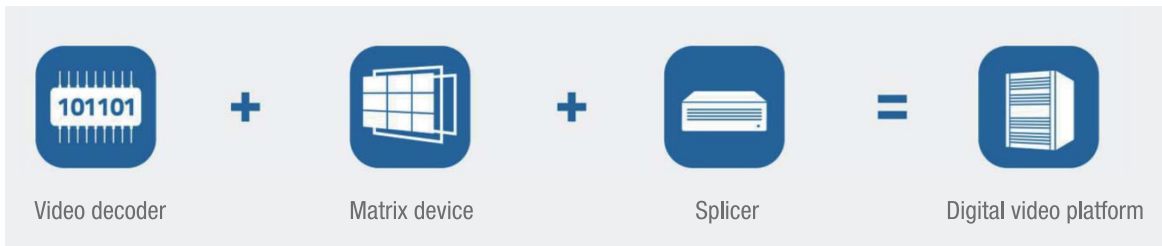

### Brand-New Application Mode

The platform integrates video decoding, matrix switchover, and splicing functions. A single device can be used as the decoder, matrix and splicer. This simplifies the system structure and lowers construction costs.

Mobile device  
control

Data Storage

Multi-image  
splicer

Multi-user  
interface and  
management  
system

Multi-image  
access

HD GID support



# System Topology

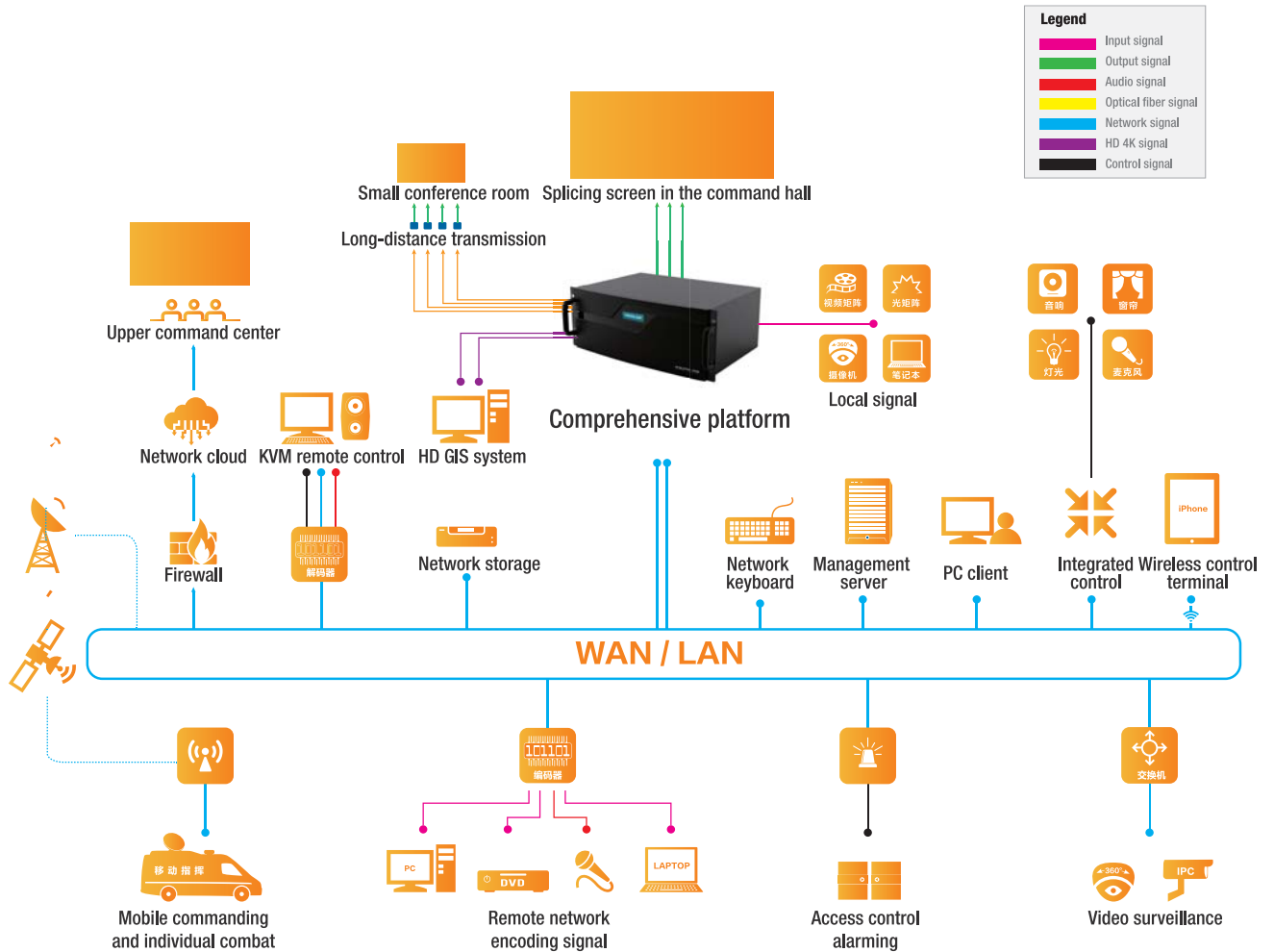

# Applications



# PARAMETER

Model	CR0.9	CR1.2	CR1.5	CR1.9
Pixel Pitch	0.953 mm	1.27 mm	1.58 mm	1.906 mm
Panel Dimensions (W x H x D)	610×343×67 mm	610×343×67 mm	610×343×67 mm	610×343×67 mm
Panel Resolution	640×360 pixels	480×270 pixels	384×216 pixels	320×180 pixels
Panel Weight	6 kg	6 kg	6 kg	6 kg
Panel Material	Aluminum	Aluminum	Aluminum	Aluminum
Module Dimensions (W x H)	152,5×171,5 mm	152,5×171,5 mm	152,5×171,5 mm	152,5×171,5 mm
Brightness	600 nits	600 nits	700 nits	800 nits
Refresh Rate	1920 Hz	1920 ~ 3840 Hz	1920 ~ 3840 Hz	1920 ~ 3840 Hz
View Angle (Hori./Vert.)	160°/120°	160°/140°	160°/140°	160°/140°
Input AC Voltage	100 ~ 240V	100 ~ 240V	100 ~ 240V	100 ~ 240V
Power (Max/Avg)	610/203 W/m <sup>2</sup>	610/203 W/m <sup>2</sup>	610/203 W/m <sup>2</sup>	610/203 W/m <sup>2</sup>
Working Temperature	-10 ~ +40 C	-10 ~ +40 C	-10 ~ +40 C	-10 ~ +40 C
Ingress Protection (Front/Rear)	IP40/IP21	IP40/IP21	IP40/IP21	IP40/IP21

★ Shenzhen Absen Optoelectronic Co., Ltd. reserves the right to modify product design, specifications, and parameters without further notice.  
Photos are used for illustration purpose only as products may differ from these photos. All rights reserved by Shenzhen Absen Optoelectronic Co., Ltd.



**Shenzhen Absen Optoelectronic Co., Ltd.**

18-20F Building 3A, Cloud Park, Bantian, Longgang  
District, Shenzhen 518129, P.R.China

T: +86-755-89747399 E: absen@absen.com  
F: +86-755-89747599 W: www.absen.com

**Absen Inc.**

7120 Lake Ellenor Drive, Orlando,  
FL 32809, USA

T: +1-407-203-8870 E: info@usabsen.com  
F: +1-407-203-8873 W: www.usabsen.com

**Absen GmbH**

Eisenstraße 5, 65428 Rüsselsheim a.M.,  
Germany

T: +49 (0) 6142 78935-0 E: europe@absen.com  
F: +49 (0) 6142 78935-29 W: www.absen-europe.com