

# D-CERNO

## Wired Conference System



---

Installation and User Manual

---



# Table of Contents

Table of Contents .....	3
Section 1 – General Information .....	7
1. Copyright Statement.....	9
2. Trademarks .....	10
3. Conformity info .....	10
4. Safety Instructions.....	10
4.1. Important safety instructions.....	10
4.2. Power Connections.....	13
5. D-Cerno System Architecture .....	14
5.1. System components .....	14
5.2. Network structure .....	14
Section 2 – System Components .....	17
6. Table Top Delegate units.....	19
6.1. Introduction .....	19
6.2. Controls and indicators.....	19
6.3. Installation .....	21
6.4. Microphones .....	22
6.5. Maintenance .....	23
7. Central Control unit .....	24
7.1. Introduction .....	24
7.2. Controls and indicators.....	24
7.3. External Connections .....	24
7.4. Startup.....	25
8. Power Supply .....	26

---

<b>9.</b>	<b>System cables .....</b>	<b>26</b>
<b>Section 3 – Configuring the system .....</b>		<b>27</b>
<b>10.</b>	<b>Menu Navigation .....</b>	<b>29</b>
<b>11.</b>	<b>Menu overview .....</b>	<b>29</b>
<b>Section 4 – The Menu explained .....</b>		<b>34</b>
<b>12.</b>	<b>Main Menu.....</b>	<b>35</b>
<b>12.1.</b>	<b>Loudspeaker volume.....</b>	<b>35</b>
<b>12.2.</b>	<b>Conference modes.....</b>	<b>35</b>
<b>12.3.</b>	<b>Vox setting .....</b>	<b>36</b>
<b>12.4.</b>	<b>Microphone preset .....</b>	<b>37</b>
<b>12.5.</b>	<b>Microphone Limit .....</b>	<b>37</b>
<b>12.6.</b>	<b>Eco mode .....</b>	<b>38</b>
<b>12.7.</b>	<b>Settings menu .....</b>	<b>38</b>
<b>12.8.</b>	<b>Headphone volume .....</b>	<b>38</b>
<b>12.9.</b>	<b>Chime.....</b>	<b>38</b>
<b>12.10.</b>	<b>External processing.....</b>	<b>38</b>
<b>12.11.</b>	<b>Audio out .....</b>	<b>40</b>
<b>12.12.</b>	<b>Audio In .....</b>	<b>40</b>
<b>12.13.</b>	<b>Master-slave configuration .....</b>	<b>40</b>
<b>Section 5 – Webserver and recording.....</b>		<b>43</b>
<b>13.</b>	<b>Web-browser .....</b>	<b>44</b>
<b>13.1.</b>	<b>How to connect .....</b>	<b>44</b>
<b>13.2.</b>	<b>Volume .....</b>	<b>47</b>
<b>13.3.</b>	<b>Recorder .....</b>	<b>47</b>
<b>13.4.</b>	<b>Configuration .....</b>	<b>49</b>
<b>Section 6 – Appendix.....</b>		<b>53</b>
<b>14.</b>	<b>Default Settings.....</b>	<b>55</b>
<b>15.</b>	<b>System update procedure .....</b>	<b>57</b>
<b>16.</b>	<b>Camera protocol.....</b>	<b>59</b>
<b>17.</b>	<b>D-Cerno CUR startup options .....</b>	<b>60</b>

<b>18.</b>	<b>Technical Data .....</b>	<b>61</b>
<b>18.1.</b>	<b>Electrical and Electro Acoustical Characteristics .....</b>	<b>61</b>
<b>18.2.</b>	<b>Mechanical Characteristics.....</b>	<b>61</b>
<b>18.3.</b>	<b>Environmental Characteristics.....</b>	<b>61</b>
<b>18.4.</b>	<b>System limits .....</b>	<b>61</b>
<b>18.5.</b>	<b>Webbrowser.....</b>	<b>61</b>
<b>18.6.</b>	<b>USB specs .....</b>	<b>62</b>



## **Section 1 – General Information**





# 1. Copyright Statement

No part of this publication or documentation accompanying this product may be reproduced in any form or by any means or used to make any derivative such as translation, transformation, or adaptation without the prior written permission of the publisher, except in case of brief quotations embodied in critical articles or reviews. Contents are subject to change without prior notice.

Copyright© 2012 by Televic Conference NV. All rights reserved.

The authors of this manual have made every effort in the preparation of this book to ensure the accuracy of the information. However, the information in this manual is supplied without warranty, either express or implied. Neither the authors, Televic Conference NV, nor its dealers or distributors will be held liable for any damages caused or alleged to be caused either directly or indirectly by this book.

## 2. Trademarks

All terms mentioned in this manual that are known to be trademarks or service marks have been appropriately capitalized. Televic Conference NV cannot attest to the accuracy of this information. Use of a term in this book should not be regarded as affecting the validity of any trademark or service mark.

## 3. Conformity info

The D-Cerno Wired Conference system is compliant with following standards:

- EN60065
- EN55103-1/-2
- IEC60914

## 4. Safety Instructions

The D-Cerno Conference system is state of the art and has been designed to meet quality. Nevertheless, the individual components of the conference system can cause danger for persons and material assets if

- the conference system is not used as intended,
- the conference system is set up by personnel not familiar with the safety regulations,
- the conference system is converted or altered incorrectly,
- the safety instructions are not observed.

### 4.1. Important safety instructions

#### 1. Read Instructions

All the safety and operating instructions should be read before the product is operated.

#### 1. Retain Instructions

The safety and operating instructions should be retained for future reference.

#### 2. Heed Warnings

All warnings on the product and the operating instructions should be adhered to.

#### 3. Follow Instructions

All instructions for installation or operating / use should be followed.

#### 4. Cleaning

Unplug this product from the wall outlet before cleaning. Do not use liquid cleaners or aerosol cleaners. Use a damp cloth for cleaning.

#### 5. Ventilation

Slots and openings in the cabinet are provided for ventilation and to ensure reliable operation of the product and to protect it from overheating. These openings must not be blocked or covered. The openings should never be blocked by placing the product on a bed, sofa, rug, or other similar surface. This product should not be placed in a built-in installation such as a bookcase or rack unless proper ventilation is provided or the manufacturer's instructions have been adhered to.

#### 6. Heat

The product should be situated away from heat sources such as radiators, heat registers, stoves, or other products (including amplifiers) that produce heat.

#### 7. Attachments

Do not use attachments not recommended by the product manufacturer as they may cause hazards.

#### 8. Water and Moisture

Do not use this product near water or in a moistures environment - for example, near a bath tub, wash bowl, kitchen sink, or laundry tub; in a wet

basement; or near a swimming pool, in an unprotected outdoor installation; and the like.

#### 9. Accessories

Only use attachments/accessories specified by the manufacturer. Do not place this product on an unstable cart, stand, tripod, bracket, or table. The product may fall, causing serious injury to a child or adult, and serious damage to the product. Use only with a cart, stand, tripod, bracket, or table recommended by the manufacturer, or sold with the product. Any mounting of the product should follow the manufacturer's instructions, and should use a mounting accessory recommended by the manufacturer.

#### 10. Moving

A product and cart combination should be moved with care. Quick stops, excessive force, and uneven surfaces may cause the product and cart combination to overturn.

#### 11. Power Sources

This product should be operated only from the type of power source indicated on the marking label. If you are not sure of the type of power supply to your home, consult your product dealer or local power company. For products intended to operate from battery power, or other sources, refer to the operating instructions.

#### 12. Power Lines

An outdoor system should not be located in the vicinity of overhead power lines or other electric light or power circuits, or where it can fall into such power lines or circuits. When installing an outdoor system, extreme care should be taken to keep from touching such power lines or circuits, as contact with them might be fatal. U.S.A. models only - refer to the National Electrical Code Article 820 regarding installation of CATV systems.

#### 13. Grounding or Polarization

Do not defeat the safety purpose of the polarized or ground-type plug. A polarized plug has two blades

with one wider than the other. A grounding type plug has two blades and a third grounding prong. The wider blade or the third prong is provided for your safety. If the provided plug does not fit into your outlet, consult an electrician for replacement of the obsolete outlet.

#### 14. Power-Cord Protection

Power-supply cords should be routed so that they are not likely to be walked on or pinched by items placed upon or against them, paying particular attention to cords at plug, convenience receptacles, and the point where they exit from the product.

#### 15. Lightning

For added protection for this product during a lightning storm, or when it is left unattended and unused for long periods of time, unplug it from the wall outlet. This will prevent damage to the product due to lightning and power-line surges.

Not applicable when special functions are to be maintained, such as evacuation systems

#### 16. Overloading

Do not overload wall outlets, extension cords or integral convenience receptacles as this can result in a risk of fire or electric shock.

#### 17. Object and Liquid Entry

Never push objects of any kind into this product through openings as they may touch dangerous voltage points or short-out parts that could result in a fire or electric shock. Never spill liquid of any kind on the product.

#### 18. Inflammable and Explosive Substance

Avoid using this product where there are gases, and also where there are inflammable and explosive substances in the immediate vicinity.

#### 19. Heavy Shock or Vibration

When carrying this product around, do not subject the product to heavy shock or vibration.

## 20. Servicing

Do not attempt to service this product yourself as opening or removing covers may expose you to dangerous voltage or other hazards. Refer all servicing to qualified service personnel.

## 21. Damage Requiring Service

Unplug this product from the wall outlet and refer servicing to qualified service personnel under the following conditions:

- a. When the power-supply cord or plug is damaged.
- b. If liquid has been spilled, or objects have fallen into the product.
- c. If the product has been exposed to rain or water.
- d. If the product does not operate normally by following the operating instructions. Adjust only those controls that are covered by the operating instructions as an improper adjustment of other controls may result in damage and will often require extensive work by a qualified technician to restore the product to its normal operation.
- e. If the product has been dropped or damaged in any way.
- f. When the product exhibits a distinct change in performance-this indicates a need for service.

## 22. Replacement Parts

When replacement parts are required, be sure the service technician has used replacement parts specified by the manufacturer or have the same characteristics as the original part. Unauthorized substitutions may result in fire, electric shock, or other hazards.

## 23. Safety Check

Upon completion of any service or repairs to this product, ask the service technician to perform safety checks to determine that the product is in proper operating condition.

## 24. Coax Grounding

If an outside cable system is connected to the apparatus, be sure the cable system is grounded. U.S.A. models only: Section 810 of the National Electrical Code, ANSI/NFPA No.70-1981, provides information with respect to proper grounding of the mount and supporting structure, grounding of the coax to a discharge apparatus, size of grounding conductors, location of discharge unit, connection to grounding electrodes, and requirements for the grounding electrode.

## 4.2. Power Connections

For permanently connected equipment, a readily accessible disconnect device shall be incorporated in the fixed wiring; For pluggable equipment, the socket-outlet shall be installed near the equipment and shall be easily accessible.

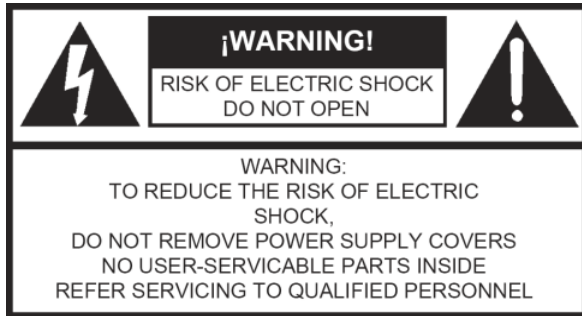

This label may appear on the bottom of the apparatus due to space limitations.



The lightning flash with an arrowhead symbol, with an equilateral triangle, is intended to alert the user to the presence of un-insulated 'dangerous voltage' within the products enclosure that may be of sufficient magnitude to constitute a risk of electric shock to persons.



The exclamation mark within an equilateral triangle is intended to alert the user to the presence of important operating and maintenance (servicing) instructions in the literature accompanying the appliance.



**Warning:**

To reduce the risk of fire or electric shock, do not expose this appliance to rain or moisture. Do not open the cabinet; refer servicing to qualified personnel only.



**Warning:**

To prevent electric shock, do not use this (polarized) plug with an extension cord receptacle or other outlet unless the blades can be fully inserted to prevent blade exposure.



**Attention:**

Installation should be performed by qualified service personnel only in accordance with the National Electrical Code or applicable local codes.



**Attention:**

Equipment with or without ON/OFF switches have power supplied to the equipment whenever the power cord is inserted into the power source; however, the equipment is operational only when the ON/OFF switch is in the ON position. The power cord is the main power disconnect for all equipment.

## 5. D-Cerno System Architecture

The D-Cerno system is a digital discussion system for small to medium size conference rooms.

The main characteristics of the system are:

- Crystal clear audio reproduction: digital signal processing, high quality GSM interference free microphone and loudspeaker, resulting in excellent intelligibility.
- Attractive, stylish design: contemporary, unobtrusive and low profile, fitting into modern and traditional style conference rooms
- Plug and Play: easy installation, up and running in no time, ideal for frequently changing environments
- High reliability: built-in redundancy feature – touch sensor technology, hygienic, easy to clean, equal performance over the entire lifespan of the product.

### 5.1. System components

A D-Cerno system consists out of the following components:

- Central unit (Art. 71.98.0320)
  - D-Cerno CU
  - D-Cerno PS
  - Mains cable
  - Conference system cable (2m)
  - Quick guide
- Central unit-R (Art. 71.98.0321)
  - D-Cerno CU-R
  - D-Cerno PS
  - Mains cable
  - Conference system cable (2m)
  - Quick guide

- Delegate unit (Art. 71.98.0301)
  - D-Cerno D
  - Conference system cable (2m)
- Chairman unit (Art. 71.98.0302)
  - D-Cerno C
  - Conference system cable (2m)
- Spare power supply (Art. 71.98.0340)
  - D-Cerno PS
  - Mains cable
- System cables, available in different lengths
  - DCC2 2m cable set: 4 x 2 m (Art. 71.98.0345)
  - DCC5 5m cable set: 4 x 5 m (Art. 71.98.0346)
  - DCC10 10m cable set: 4 x 10 m (Art. 71.98.0347)
  - DCC20 20m cable set: 2 x 20 m (Art. 71.98.0348)

Detailed info about the different components can be found in Section 2 of this manual.

### 5.2. Network structure

The central unit can control and power a total of 50 units over the four available conference ports.

The network can be structured in two ways:

- Branch configuration
- Closed loop configuration

Each branch or loop can handle a maximum of 25 units if the total cable length is respected.

The total cable length of a branch / loop cannot exceed the maximum of 400 m.

The maximal cable length between units or between units and central unit is 80 m.

The maximum power consumption of a unit is 2W.

In Figure 5.1 : D-Cerno networka graphical representation of a D-Cerno configuration is depicted.

At the right a closed loop configuration between port 3 and 4 is shown.

At the left side we see a branch configuration connected to port 1.

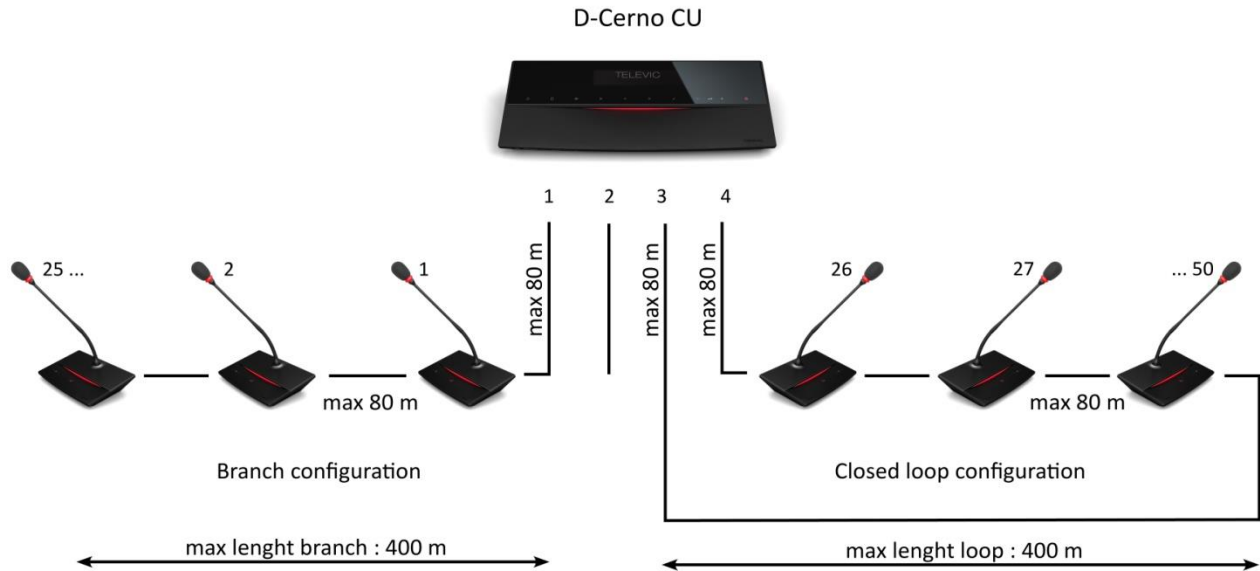

Figure 5.1 : D-Cerno network

Designing a system in a closed loop configuration provides a redundant system and thus increases the reliability of the system.

If for some reason a cable or unit gets defective the system stays operational.

The units have the possibility to detect the flow of the signal automatically providing a free port selection. If at some point no signal is provided anymore, automatically the signal flow will be reversed. As a result the system configuration stays operational.

The figure below illustrates:

- Branch configuration in normal operation
- Branch configuration with cabling error
- Loop configuration with cabling error



Figure 5.2 : D-Cerno branch configuration, no error

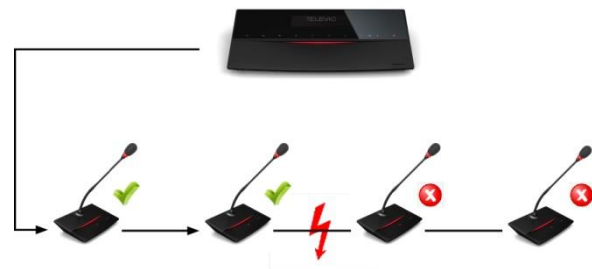

Figure 5.3 : D-Cerno branch configuration, cable error



Figure 5.4 : D-Cerno loop configuration, cable error



## **Section 2 – System Components**



## 6. Table Top Delegate units

### 6.1. Introduction

The contribution units consist out of delegate and chairman units. Both are used for speech reinforcement in a conference room. The chairman units are used to guide and control an ongoing discussion.

### 6.2. Controls and indicators

The D-Cerno delegate units have the following features:

1. **Microphone touch sensor button:**  
Activation/deactivation of the microphone. Indication LEDs show the status of the microphone. (red : active, green : request)
2. **Loudspeaker:**  
Distributes the floor channel. Mutes in case microphone is active.
3. **Headphone connector:**  
Connection of headphone to the unit. Mono- and stereo headphones can be used.
4. **Volume touch sensor buttons:**  
Change the volume level of the headphones.  
  
Remark: volume change is only possible when a headphone is connected
5. **Microphone**
6. **Led bar**  
  
Indicates the status of the unit.  
Red: unit is active  
Green: unit is in request mode  
Pressing the Next-in-line or PRIOR button on a chairman unit is indicated by illuminating the corresponding part of the led bar.

7. **NEXT button: (chairman unit only)**  
Grants the floor to the next delegate in the waiting list.
8. **PRIOR button: (chairman unit only)**  
Permanently deactivates the microphone of all active units.



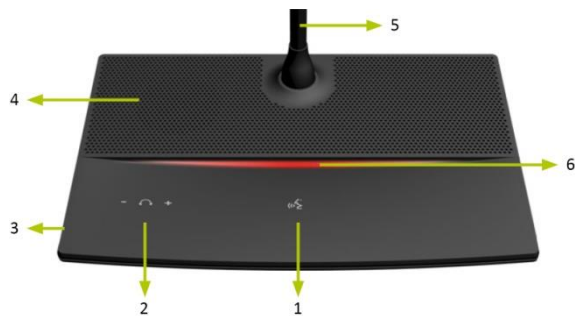

Figure 6.1: D-cerno Discussion unit

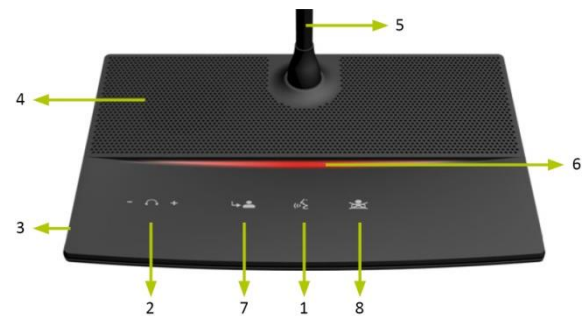

Figure 6.2: D-cerno Chairman Unit

### 6.3. Installation

D-Cerno units offer free input/output connectivity to allow flexible cabling.

The delegate units can be connected in daisy chain or in loop to ensure redundancy and increase reliability.



Figure 6.3: D-cerno connectivity

Make sure that the units are not positioned too close to each other. It is recommended to keep a distance of 1m between the units to prevent howling.

The recommended speaking distance for people to speak to the microphone is between 20 and 40 cm.

## 6.4. Microphones

### 6.4.1. Introduction

The D-Cerno microphone has a unidirectional response for optimum performance even in noisy conditions, and has a very low susceptibility to interference from mobile phones.

### 6.4.2. Electrical and acoustic properties

*Table 6.4.2: Microphone characteristics*

<b>Transducer type</b>	Back electret (condenser)
<b>Operating principle</b>	Pressure gradient
<b>Polar pattern</b>	Unidirectional, cardioid
<b>Frequency response</b>	130 Hz – 15000 Hz
<b>Nominal impedance</b>	1kOhm (at 1 kHz, drop resistance = 1k2, Vdd = 3.3VDC )
<b>Load impedance</b>	> 5kOhm
<b>Max. SPL at 1 kHz</b>	120 dB SPL
<b>Free field sensitivity</b>	7mV/Pa, +/- 3 dB at 1 kHz or (-43dB, 0dB=1V/Pa at 1kHz)
<b>Power supply</b>	3.3V DC, 0.5 mA
<b>Consumption</b>	0.5 mA (without LED ring); max. 25 mA (with illuminated ring)

## 6.5. Maintenance

### 6.5.1. General

**Caution:**

Do not put any objects on top of the units. Object falling through the holes of the unit can cause damage.

**Caution:**

Do not install the units in a location near heat sources as radiators, air ducts or direct sunlight.

**Caution:**

Make sure the units are not exposed to excessive dust, humidity, mechanical vibration or shock.

### 6.5.2. Cleaning

**Caution:**

Do not use alcohol, ammonia or petroleum solvents or abrasive cleaners to clean the units.

To keep its original condition it is advised to periodically clean the unit:

- Use a clean soft cloth that is not fully moist.
- Make sure the device is completely dry before usage.

## 7. Central Control unit

### 7.1. Introduction

The D-Cerno CU is the heart of the system. It controls all delegate units and can interconnect to other systems via the external audio connections.

The system operates in a standalone mode and controls a maximum of 50 units. Configuration can be done via the integrated menu.



Figure 7.1 : D-Cerno connectivity

### 7.2. Controls and indicators

All controls are done via touch panel by means of an intuitive user interface menu (see chapter 11)

A user can activate or select a control or menu item by touching one of the symbols underneath the display.

### 7.3. External Connections

1. +48V DC power connector



Figure 7.2 : DC power connector

2. 4 x RJ45 ports to connect up to max 50 delegate units. (max. 25 units per branch or loop).

For more information please use the power calculation tool.



Figure 7.3 : System ports

The green indicator points to detected signal, without errors (devices detected).

The yellow indicator points to error or no signal detected (no devices connected).

3. 2 x RJ45 ports



Figure 7.4 : Master – Slave ports

2 RJ-45 shielded connectors for a connection with 2 slave central units when the central unit is master in a coupled environment.

In case a larger number of units are required the system can be extended with 2 extra central units in master/slave configuration. The maximum of units is 150 (3 central units).

4. LAN connector



Figure 7.5 : LAN connector

Webserver connection (D-Cerno CU-R only)

Through the LAN connector it is possible to connect the central unit to the local network. This makes it possible to control the recording and configuration by webbrowser on your PC or mobile device.

5. Two unbalanced RCA audio output connectors to extract analog audio floor signal





Figure 7.6 : Aux Out

The green indicators light up when there is an output signal > -40dBV present.

- 6. One unbalanced RCA analog audio input connector to add external signal to the floor



Figure 7.7 : Aux in

The red indicators light up when there is an overload of the input signal (signal > +9dBV).

- 7. One balanced XLR analog audio connector to add external signal to the floor

The red indicators light up when there is an overload of the input signal.

The AUX In connection on the central unit has an XLR 3 Female connector. So a cable with an XLR 3 Male connector should be used to insert an external signal.

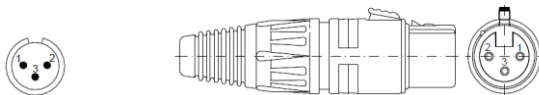

Figure 7.8 : XLR pin assignment

Pin 1	Shield
Pin 2	Signal +
Pin 3	Signal -

- 8. Headphone connector  
For headphone monitoring.

- 9. Two USB connectors can be found at the front of the D-Cerno CUR. These allow the user to record the meeting in WAV or MP3 format.

The USB memory sticks have to be formatted in FAT file system. NTFS is not supported by the D-Cerno CUR. To guarantee a correct recording we advise to use USB 2.0.



Figure 7.9: Headphone and USB connectors

 **Note:**  
Before plugging in a USB, please check the amount of free recording space.

## 7.4. Startup

 **Note:**  
Before switching on the central unit please make sure all units are correctly connected to the Central Unit.

To start the D-Cerno CUR there are 2 options. The first most trivial option is that you touch and hold the on/off sign for 3 seconds. A second option is to automatically let the D-Cerno CUR start when the power supply is connected. For this option you need to physically change a dipswitch on the electronic circuitry inside the D-Cerno CUR. This procedure is described in the appendix of this manual at chapter 17.



Figure 7.10: ON/OFF sign

When the red ON/OFF led is blinking the meeting can be started and settings can be adjusted. USB and network functionalities (recording, webbrowser) are available after 15 seconds, when the red ON/OFF stops blinking and extinguishes.

Then the image depicted on figure 7.11 appears on the screen and the device is ready to record.



Figure 7.11: USB and network functionalities enabled

To switch the device off, touch and hold the ON/OFF switch for 3 seconds.

- DCC2 2m cable set: 4 x 2 m (Art. 71.98.0345)
- DCC5 5m cable set: 4 x 5 m (Art. 71.98.0346)
- DCC10 10m cable set: 4 x 10 m (Art.71.98.0347)
- DCC20 20m cable set: 2 x 20 m (Art. 71.98.0348)

## 8. Power Supply

The power supply can operate on an input voltage range of 100-240Vac , 47-63Hz.

The output voltage is 48V dc – 3.15A max

## 9. System cables

Cables used in the D-Cerno system are shielded Cat5e (AWG 24 FTP) cables with shielded RJ45 connectors.



**Note:**

The use of shielded Cat5e (AWG 24 FTP) cables with shielded RJ45 connectors is mandatory.

Contribution units and central units are standard delivered with a premade cable of 2m.

In case additional cables are required Televic has standard pre-made cables available in different lengths.

## **Section 3 – Configuring the system**



## 10. Menu Navigation



The D-Cerno CU-R has 3 extra record buttons. With this buttons it is possible to start/stop or pause a recording.

- Start recording
- Stop recording
- Listen/ pause recording



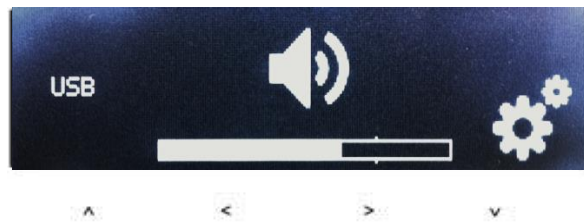



After start-up of the system, the main menu shows up.



The main menu consists of a system volume section and a configuration menu entrance.

The main system volume can be adapted with the < > keys or via the dedicated volume buttons.

The menu consists out of several levels. Each level functions as a ring structure navigating from the last to first item or vice versa.

-  Enter the configuration menu
-  Enter the next menu level
-  Return to previous menu level
-  Select previous menu item
-  Select next menu item
-  Highlight of selected item

The loudspeaker volume settings can be done directly on the central unit.

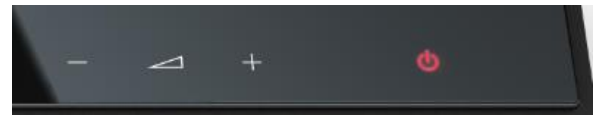





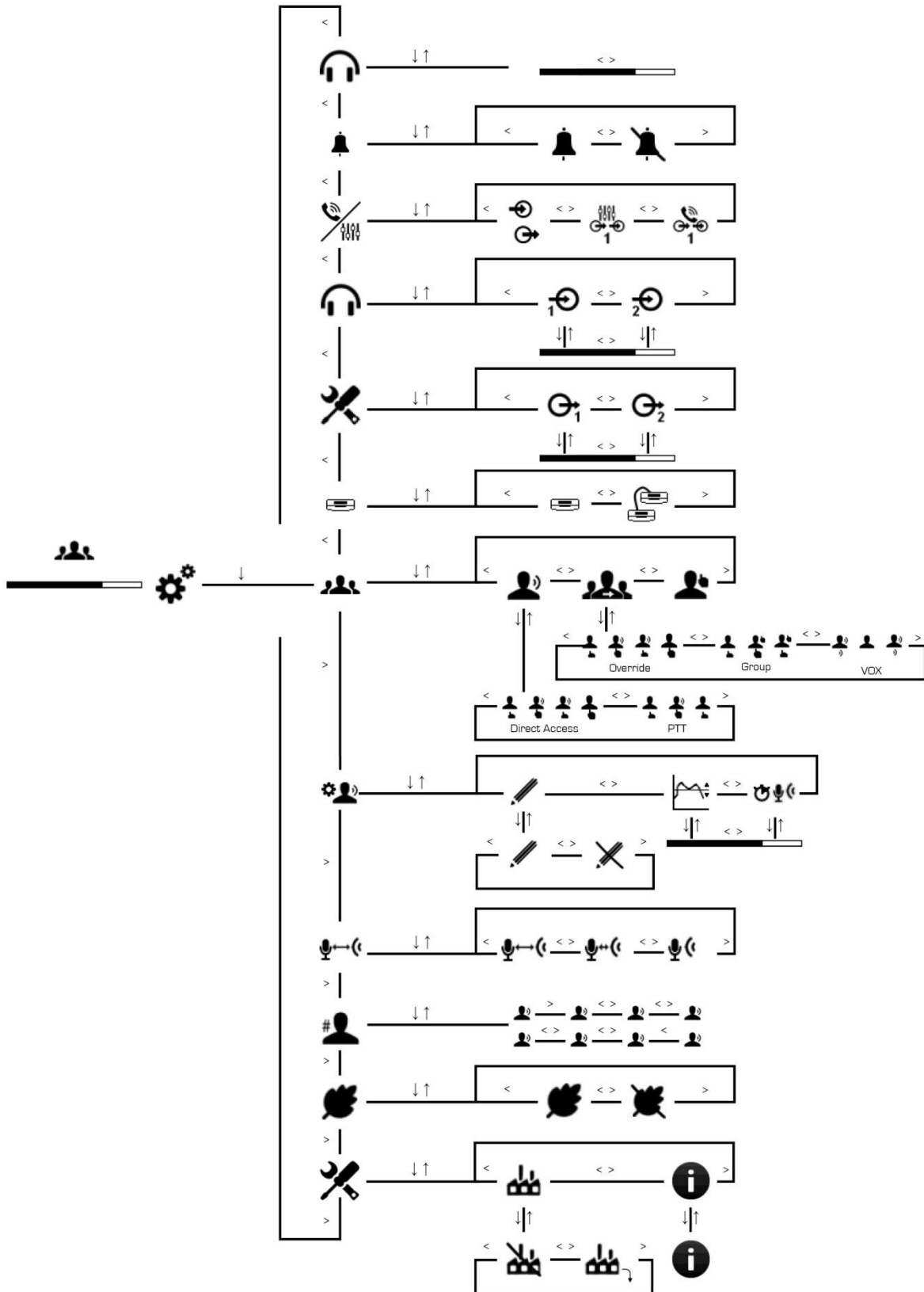





















## 11. Menu overview





The menu structure on the next pages can be used as a quick reference guide to configure the conference systems.



Level			Description
L1	L2	L3	
			Microphone mode
			Direct Access
			Toggle
			Push to talk
			FIFO
			Toggle
			Group
			VOX
			Request
			Vox settings
			Pencil drop
			Pencil drop on
			Pencil drop off
			Sensitivity
			Sensitivity adjustment
			Release time
			Release time adjustment
			Microphone sensitivity preset
			Preset Far
			Preset Average
			Preset Close
			Number of active speakers allowed
			Representation of speaker, maximum 8
			Eco Power

		Eco Power on
		Eco power off
	Settings menu	
		Factory settings
		Factory settings OFF
		Activate factory settings
		System information
		Information about software and hardware versions of the central unit
	Headphone volume	
		Headphone volume adjustment
	Chime	
		Chime on
		Chime off
	External processing	
		Independent aux settings
		External Processing
		Remote Conferencing
	Auxiliary OUT settings	
		Aux OUT 1
		Aux OUT 1 volume adjustment
		Aux OUT 2
		Aux OUT 2 volume adjustment
	Auxiliary IN settings	
		Aux IN 1
		Aux IN 1 volume adjustment
		Aux IN 2



	Aux IN 2 volume adjustment
	Master/slave configuration
	Slave configuration
	Master configuration

## **Section 4 – The Menu explained**

## 12. Main Menu

Config menu selection  allows entering the different settings as described below

All selected settings are activated immediately except for “restore factory settings” which needs additional confirmation.

### 12.1. Loudspeaker volume



Adjust the loudspeaker volume of the system.

The loudspeakers setting are the same for a delegate as for a chairman.

Loudspeaker volume is adjustable between 0dB and -46dB + “OFF”

### 12.2. Conference modes

In order to guide a conference several conference modes are available.

Chairman microphones are not affected by any conference mode and can be activated at any time with a maximum of 8 chairman units.

#### 12.2.1. Direct Access



This enables the participant to turn on his microphone at any time by pressing the MIC icon on his conference unit.



Several participants can be active simultaneously until the microphone limit setting (see chapter 12.5) is reached.

The chairman can cancel all the active microphones by short pressing the PRIOR icon. This can cause a chime audio signal (on the condition this setting is activated: see chapter 12.9).



Holding the PRIOR button will temporarily mute all active microphones. Releasing the button will return the state of the microphone before the PRIOR button was pressed.

#### Activation mode



In the direct access mode there is an additional setting to define the way a delegate is granted the floor.

#### Toggle

Represented by animation sequence



The microphone icon needs to be pressed to activate the unit and once more to deactivate the unit.

#### Push to talk

Represented by animation sequence



The microphone is only active as long as the MIC icon is pressed.

#### 12.2.2. Override (1-8)



Makes it possible to activate 1 to 8 delegates simultaneously depending on microphone limit setting (see chapter 12.5)

Whenever the microphone limit is reached, and a delegate presses the microphone icon, the longest active microphone will be deactivated.

The chairman can cancel all the active microphones by short pressing the PRIOR icon.



Holding the PRIOR button will temporarily mute all active microphones. Releasing the button will return the state of the microphone before the PRIOR button was pressed.

### Activation mode



In the override mode there is an additional setting to define the way a delegate is granted the floor.

### Toggle

Represented by animation sequence



The microphone icon needs to be pressed to activate the unit and once more to deactivate the unit.

### VOX



The microphone of the delegates will be activated based on the fact that they start to talk. Once they stop talking the microphone will automatically be switched off when the release time has expired (see chapter 10).

### 12.2.3. With request



Whenever the microphone limit is reached pressing the MIC icon will add the delegate in a waiting list.

The unit will enter into request state.



A unit in request is visualized via the green light bar on the delegate unit and by blinking the microphone led ring.

The chairman can activate delegate unit that are in request state by pressing the NEXT icon on his unit.



The light bar of first delegate unit in the queue list will become red and the microphone will be activated.

The chairman can cancel all the active microphones by short pressing the PRIOR icon.



Holding the PRIOR button will temporarily mute all active microphones. Releasing the PRIOR button will return the status of the microphones as before the PRIOR button was pressed.

## 12.3. Vox setting



### 12.3.1. Pencil drop



This setting allows the elimination of the activation of microphones by short sounds for example when a pencil is dropped on a desk.

The Pencil drop setting can be set on or off.

### 12.3.2. Sensitivity



Each room has a different acoustic. With this setting it is possible to adjust the sensitivity of the VOX mode.

The voice activation of a microphone is triggered by a sound level, adjustable between 0 and -24 dBFs.

### 12.3.3. Release time



A voice activated microphone will be switched off when, during a certain time, no sound is detected. This time is adjustable between 1 and 10 seconds.

## 12.4. Microphone preset



There are 3 limiter gain presets to choose from. The choice between these 3 will depend on the distance between the speaker and the microphone.

This setting influences the sensitivity and the dynamic range of the microphones.

Each step (far, average and close) causes a halving or doubling off the distance from the speaker to the microphone to have the same output level.

Below you can find the relation between microphone sensitivity preset, used distances between microphone and speaker and output level.

	Relative output level at fixed distance between microphone and speaker
Close	Level reference
Average	Level reference + 6dB
Far	Level reference + 12dB

	Change in distance between speaker and microphone to obtain the same output level
Close	distance reference
Average	distance reference x 2
Far	distance reference x 4

There is also a fixed automatic gain reduction setting that reduces the volume per active microphone depending on the total number of active microphones. See graph below:

### Auto gain reduction

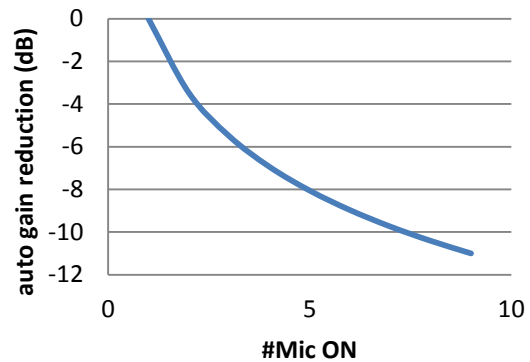

## 12.5. Microphone Limit



The maximum open microphones at the same time can be chosen between 1 and 8.

The value of this menu item is represented by a number of delegate icons. e.g. 4 open microphones



On top of the maximum number of active delegates

it is possible to activate a maximum of 8 chairman units.

## 12.6. Eco mode



The central unit has an ECO function that is going into low power mode when no sound has been detected for more than 30 minutes.

The eco mode can be set on or off.

## 12.7. Settings menu



### 12.7.1. Factory settings



When the factory settings reset is selected and confirmed, the CU will reboot with its default settings. (See chapter 14)

If a factory settings reset is required, please wait until the D-Cerno CU has completely started up, so the ON/OFF LED is switched off. Then a factory reset can be performed.

### 12.7.2. System info



Displays general system info as shown in example below

Software version, serial number, IP address, subnet mask and MAC address of the CUR.

V	0801
SN	13A00009
IP	192.168.0.20
SM	255.255.255.0
MAC	00:0E:3D:10:04:D6

## 12.8. Headphone volume

Adjust the headphone volume of the CU



The headphone volume of the central unit can be adjusted via the central unit menu.

## 12.9. Chime



Whenever the chairman uses the prior button, a chime tone will be audible

The chime mode can be set on or off.

## 12.10. External processing

### 12.10.1. Independent aux settings



Auxiliary input and output settings are independent from each other and allow external signal to be added to the floor and to extract the total floor signal Audio path for Independent Aux settings.

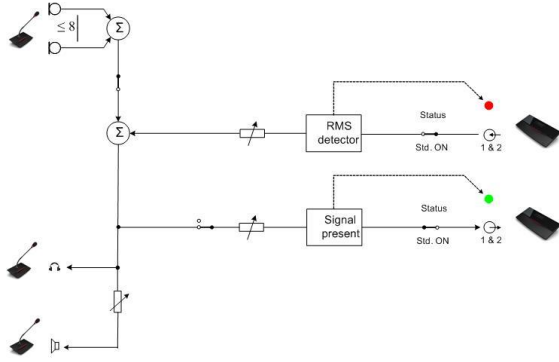

Figure 12.1 : Normal audio path

### 12.10.2. Remote Conferencing



Remote conferencing option gives the possibility to connect a central unit to e.g. a video conferencing system or telephone coupler. To prevent echoing, the remote conferencing option needs to be set.

**Note:**  
 When selecting “Remote conferencing, Aux volume settings are set to default values!  
  
 So Aux input – output levels have to be set to desired values AFTER selecting “Remote conferencing”

### Audio path for N\_1

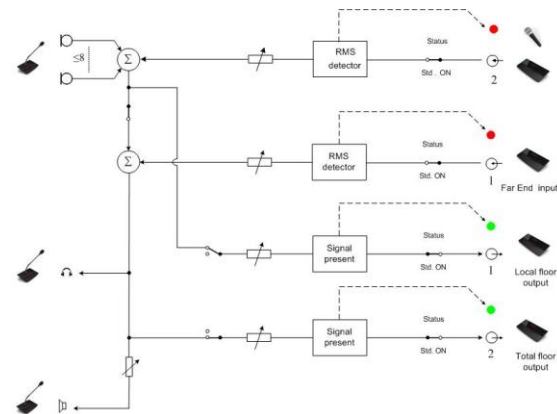

Figure 12.2 : Remote conferencing audio path

### 12.10.3. External Equalizer



To avoid feedback or to equalize audio signals it is possible to connect external equipment to the central unit. When this setting is chosen, the floor signal (mics + Aux IN2) will be routed to both AUX OUT. The signal present at AUX IN1 will be used as the new floor channel and audible on the units loudspeakers. This way it is possible to use external audio equipment like equalizers, feedback destroyers or mixers. The schematic below summarizes this feature.

The signal at both AUX OUT will be the sum of the microphones and the AUX IN2.

### Audio path for external equalizer Mode

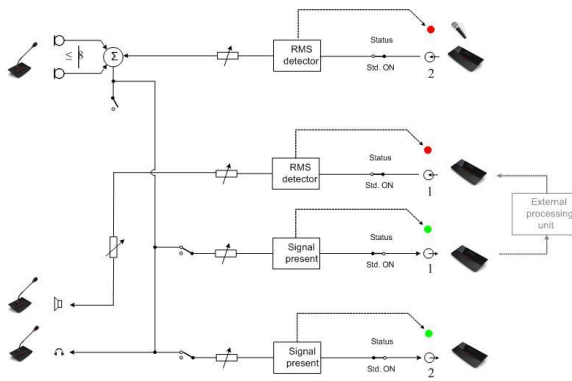

Figure 12.3 : External equalizer audio path



**Note:**

“Remote conferencing” and “External Equalizer” audio paths apply only to Aux In 1 and Aux Out 1.

In “remote conferencing” setup mode, Aux Out 1 is considered as “local floor” out and Aux Out 2 is considered as “total floor” out.

Aux Input 1 is used as “Far End input”, so this signal will not be part of the Aux Out 1 signal.

Aux Input 2 (XLR) can also be used to add a signal (e.g. from external microphones) to the local floor.



**Note:**

When selecting “External equalizer”, Aux volume settings are set to default values!

So Aux input – output levels have to be set to desired values AFTER selecting “External Equalizer”

## 12.11. Audio out



The D-Cerno CU has 2 auxiliary output RCA connectors.

On each output there is also an activity indication. (Led is on when level > -40dBV)

The output gain is adjustable between +24dB and -51dB + “OFF”

Default gain value = 0dB

10dBV (=0dBFS)

## 12.12. Audio In



Two auxiliary line inputs are available on the central unit.

Aux IN1: RCA connector

Aux IN2: XLR connector

On each input there is also an overload led indication. (Led is on when input level > 9dBV)

The input gain is adjustable between +24dB and -51dB + “OFF”

Default gain value = 0dB

10dBV (=0dBFS)

## 12.13. Master-slave configuration

Whenever an installation requires more than 50 units the system can be extended using 1 or 2 extra central units in a master/slave configuration.

The system can be extended to a maximum of 150 units. One D-Cerno central unit acts like a master whereas the other central units are configured as slave units.



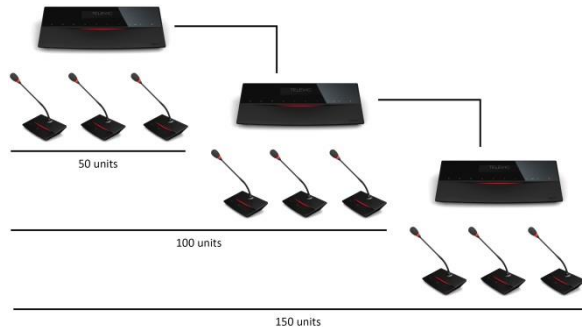

If the icon like picture below is selected, the D-Cerno central unit will then act as a master.



If the icon like picture below is selected, the D-Cerno central unit will then act as a slave.

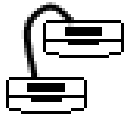

The menu of a slave central unit cannot be accessed. That means that all settings need to be done on the master central unit. For example: initialization of the units, volume settings...

Also, the recording functionalities and audio insert functionalities are disabled in slave central units.



## **Section 5 – Webserver and recording**

## 13. Web-browser

### 13.1. How to connect

#### 13.1.1. Step 1 – PC or MAC TCP/IP setup

 **Note:**  
The *D-cerno CU-R* has a default fixed IP address and subnet mask:

- IP: 192.168.0.20
- Subnet mask: 255.255.255.0

In order to access the built-in webserver for the first time, the TCP IP settings from the PC or MAC must be modified. A fixed IP address has to be set. Therefore follow the instructions below.

#### Assigning a Static IP Address in *WINDOWS 7*

- Go to 'Control Panel' (refer to Figure 13.1)
- Double-click on Network and Sharing center

Figure 13.1: Control Panel

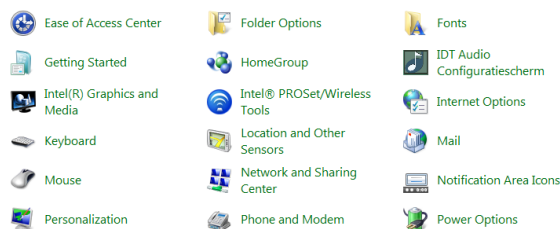

- Click on Change adapter settings (Refer to Figure 13.2)

Figure 13.2: Network and sharing

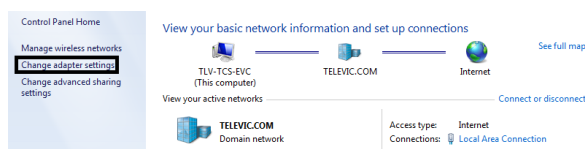

- Right-click on Local Area Connection ( refer to Figure 13.3)
- Click on Properties

Figure 13.3: Local Area Connections

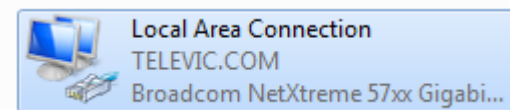

- Click on Internet Protocol 4 (TCP/IPv4) (refer to Figure 13.4).

Figure 13.4: Local Area Connections Properties

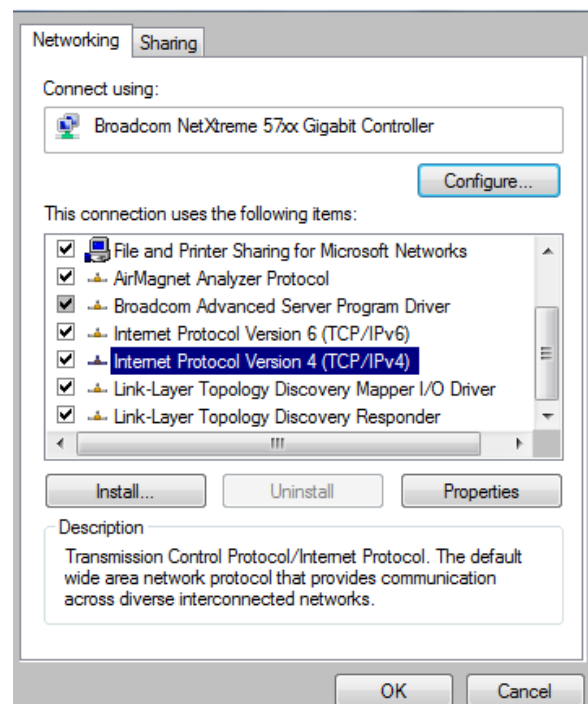

- Click properties
- Input your IP Address and subnet mask (refer to Figure 13.5).  
The IP Addresses on the network must be within the same range. The default IP address from the central unit is 192.168.0.20 so the computer should have an IP Address that is within the same subnet, like 192.168.0.11 and 192.168.0.21. The subnet mask must be the same for all equipment on the network: 255.255.255.0)
- Click OK

Figure 13.5: TCP/IP properties

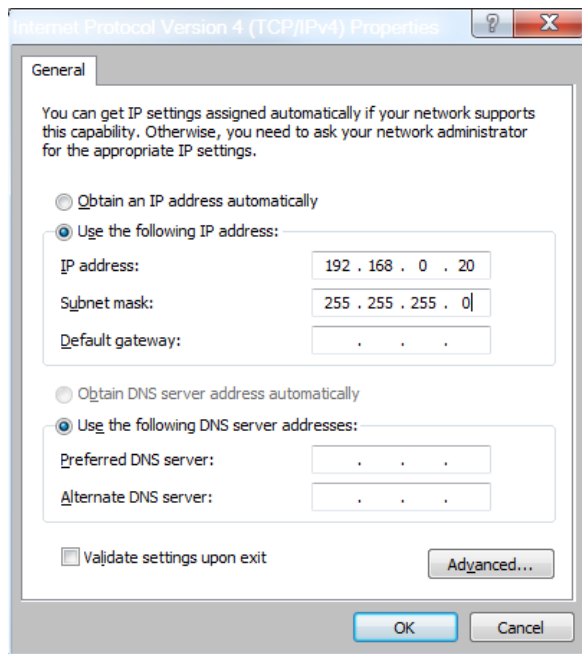

### Assigning a Static IP Address with MACINTOSH OS X

- Go to the Apple Menu and select System Preferences



- Click on Network
- Select Built-in Ethernet in the Show pull-down menu
- Select Manually in the Configure pull-down menu
- Input the Static IP Address and the Subnet Mask Address in the appropriate fields. The IP Addresses on the network must be within the

same range. The default IP address from the central unit is 192.168.0.20 so the computer should have an IP Address that is sequential, like 192.168.0.11 and 192.168.0.24. The subnet mask must be the same for all equipment on the network: 255.255.255.0.

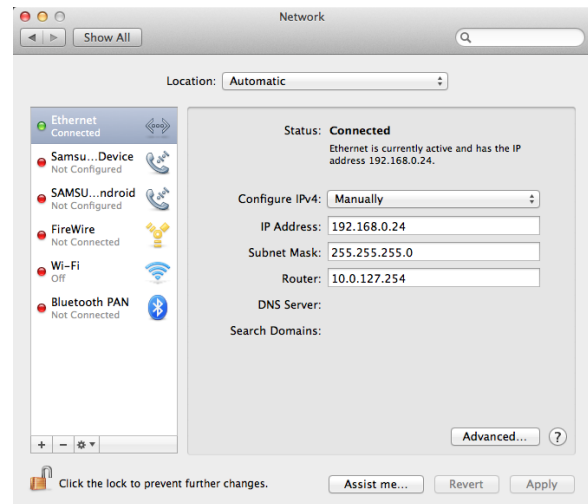

- Click Apply Now



#### Note:

If you have a proxy server or firewall installed on your computer check the connection restrictions to the D-Cerno unit IP address and content that uses java scripts. Please refer to the documentation that came with your installation for the correct settings.



#### Reference:

Please refer to the documentation that came with your PC or MAC installation for additional information and the correct settings.

## Assigning multiple IP Addresses (IP – Aliasing)

To use multiple tcp\_ip addresses on your PC, set a fixed IP address first as explained above and add the appropriate Subnet Mask, Default Gateway and the DNS server addresses.

The Default Gateway and DNS servers can be determined by executing the command “`ipconfig /all`” in a “cmd” screen

Windows 7: Click on start -> enter “cmd” in the search bar and press enter



Figure 13.6: Command Prompt

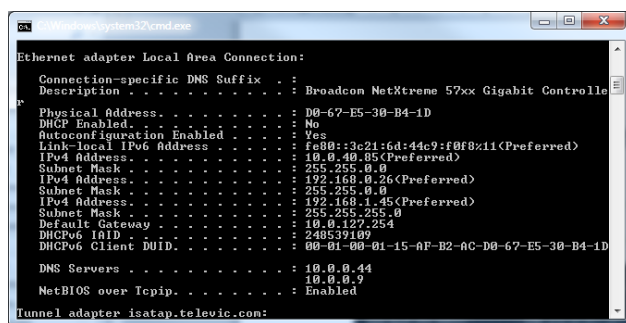

In this example the PC has normally “10.0.40.85” as IP address. Now IP Address “192.168.0.26” (e.g.) has to be added to be able to access the webserver of the central unit.

(Refer to Figure 13.7).

Figure 13.7: DNS and gateway settings

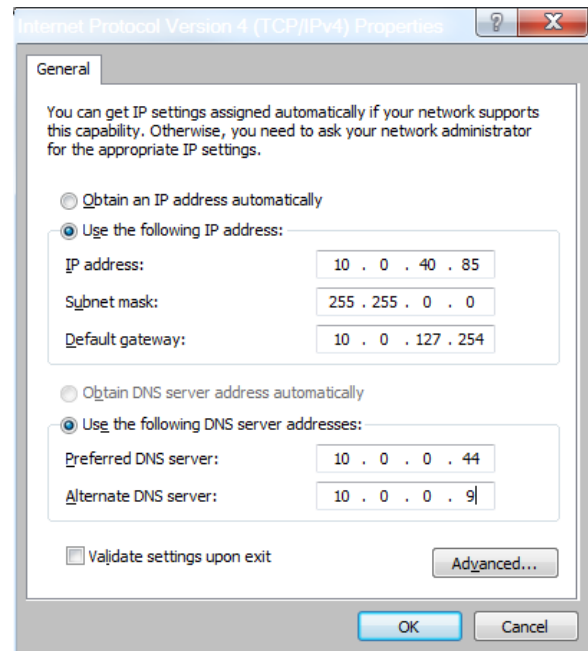

Next click on “Advanced” and “Add”... to add IP Address(es) and click 2x OK. (Refer to Figure 13.9).

To assign multiple IP addresses on a MAC we kindly refer to an external document on the Televic partner domain.

Figure 13.8: Adding IP-address

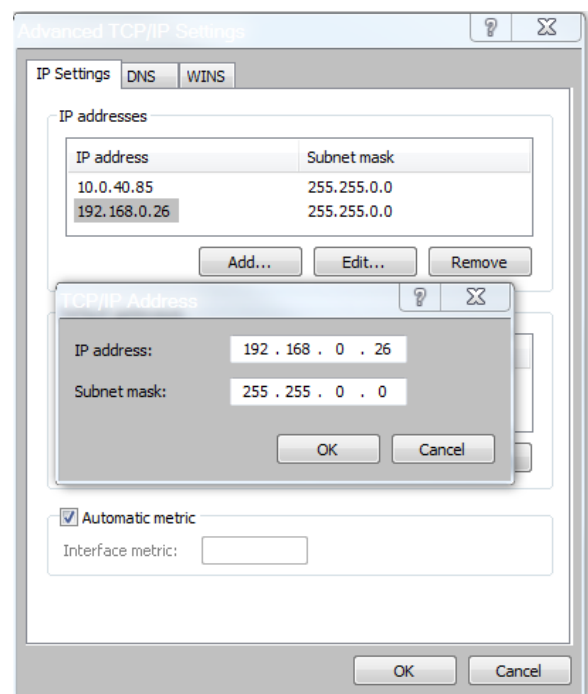

### 13.1.2. Step 2 – Cable setup

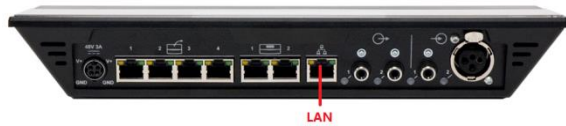

Connect your computer or smartphone (by means of a router) to the LAN port using a straight-through patch cable.

### 13.1.3. Step 3 – Accessing the webserver

The webserver is HTML 5 based webserver, which is compatible with mobile devices such as iPhone, Android or Ipad.

Figure 13.9: Internet Explorer address bar

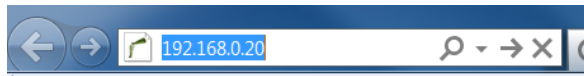

- Open Internet Explorer or any other browser
- Enter 192.168.0.20 into the address bar, push enter

Figure 13.10: Login screen

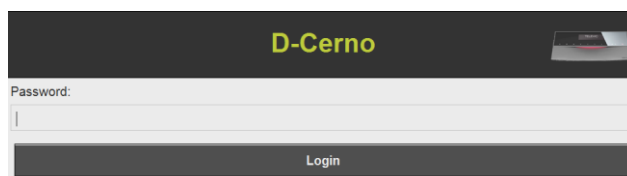

- The default password is "1234"
- Click "Login"

### 13.1.4. Step 4 – Default screen

After you successfully establishing a connection to the D-Cerno webserver and passing the password screen, the default D-Cerno screen appears.

Figure 13.11: Default screen

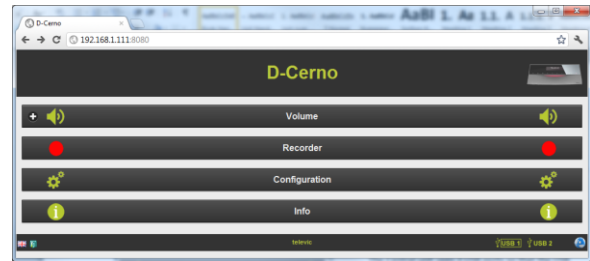

## 13.2. Volume

After you successfully access the D-Cerno webbrowser for the first time (refer to 13.1'How to connect') you can change the volume settings of the central unit, directly from the webbrowser.

- The volume can directly be modified with the slide bar.

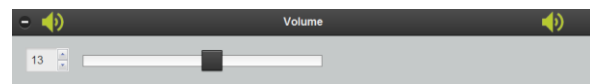
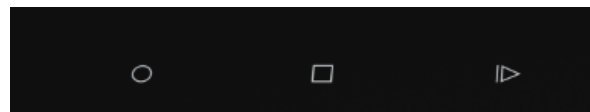

Figure 13.12: Volume setting

## 13.3. Recorder

### 13.3.1. Central unit

Figure 13.13: Record buttons central unit



The D-Cerno CU-R has 3 extra record buttons. With this buttons it is possible to start/stop or pause a recording from the central unit.

- Start recording
- Stop recording
- Listen/ pause recording

At the front of the central unit there is a possibility to connect two USB storage devices for direct recording of the meeting. For more information about the USB storage devices, please refer to paragraph 7.3: External connections.

The recording of a meeting can be saved in MP3 or WAV format.

The Central unit uses 2 USB ports so that the USB devices can take over from each other. If one USB device is full, the other one will take over.

In the picture below you can see the different statuses of the USB devices. These are displayed on the central unit.

Figure 13.14: USB status

USB	Idle		USB1 active USB2 present + error
	USB 1 active		USB1 present + error USB2 active
	USB 2 active		USB1 active + error USB2 present + error
	USB 1 active USB 2 present		USB1 present + error USB2 active + error
	USB 1 present USB 2 active		USB1 full
	USB 1 active + error		USB2 full
	USB 2 active + error		USB1 full USB2 active
	USB1 active + error USB2 present		USB1 active USB2 full
	USB 1 present USB2 active + error		
			USB1 almost full USB2 present

		USB1 present USB2 almost full
		USB1 almost full
		USB2 almost full
		USB1 full USB2 almost full
		USB1 almost full USB2 full

The recording can be started /stopped, played or paused from the central unit with the record buttons.

### 13.3.2. Webbrowser recording

More advance control can be done via the webserver:

- **Pause/stop or start a recording:**

A recording can be paused, stopped or started with these 3 buttons. You can also see how long ago a record is started.

Figure 13.15: Pause/ stop or start a recording



- **Content of devices:**



With the webbrowser it is possible to see on which USB device the recording is stored. On the left corner you can see the time remaining for recording on the USB device. This is automatically adjusted according to the used recording format. The size of the recording is displayed next to the recording.

Figure 13.16: Content of devices



- **Playback:**

Playing the file can be done by pressing on the recorded file.

- **Delete:**

A recording can also be deleted by pressing on the delete button.

Figure 13.17: Delete a recording



- **Switch active USB device:**

By using the switch button it is possible to switch between the USB devices. This can be done before recording or when a recorded is started.

Figure 13.18: Switch USB device



## 13.4. Configuration

The following settings can be accessed on both the central unit and the webbrowser. That's why we will

refer to paragraph **Error! Reference source not found.** for the explanation of the different options.

- **Volume:**

Refer to chapter **Error! Reference source not found.:** oudspeaker volume

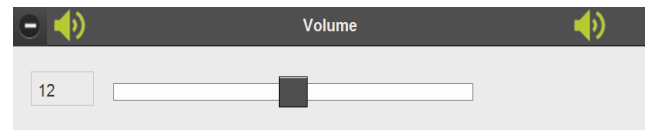

- **Conference mode:**

Refer to chapter **Error! Reference source not found.:** onference modes

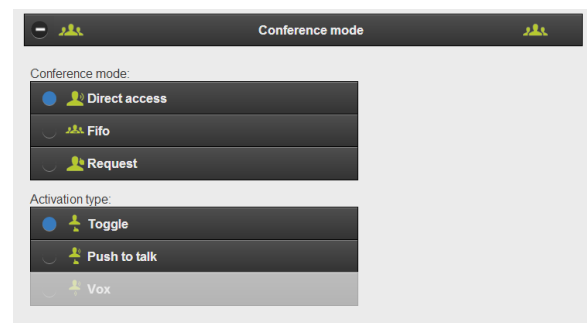

- **Vox settings:**

Refer to chapter **Error! Reference source not found.** **Error! Reference source not found.:** Vox settings

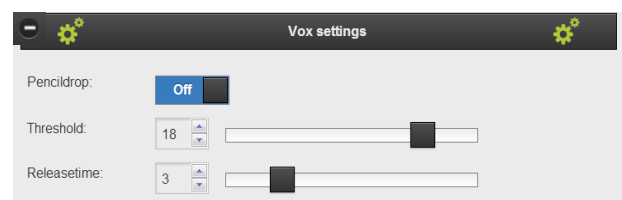

- **Microphone preset:**

Refer to chapter **Error! Reference source not found.:** icrophone preset

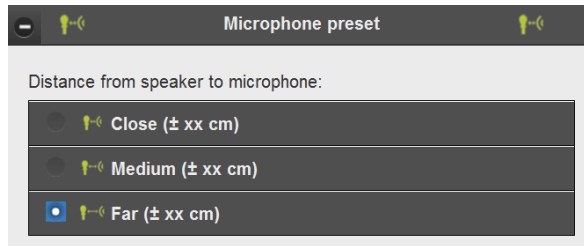

- **Max number of open microphones:**

Refer to chapter 12.5: Microphone Limit

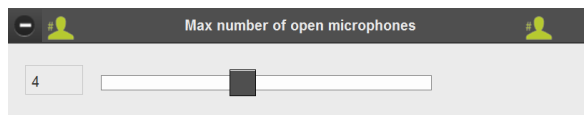

- **Eco:**

Refer to chapter **Error! Reference source not found.:** co mode

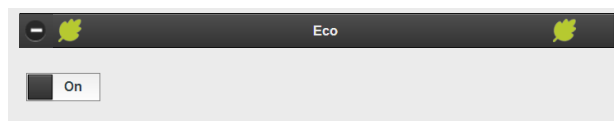

- **Factory settings:**

Refer to chapter **Error! Reference source not found.:** Factory settings

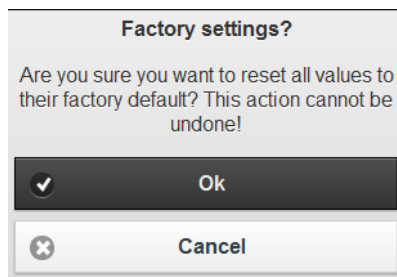

- **Headphone:**

Refer to chapter **Error! Reference source not found.:** eadphone volume



- **Chime:**

Refer to chapter **Error! Reference source not found.:** hime

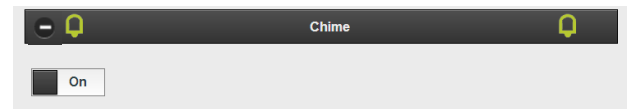

- **N-1/external equalizer:**

Refer to chapter **Error! Reference source not found.:** xternal processing

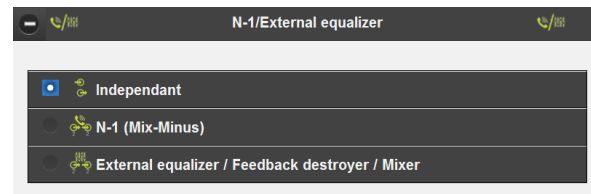

- **Audio in:**

Refer to chapter **Error! Reference source not found.:** udio in

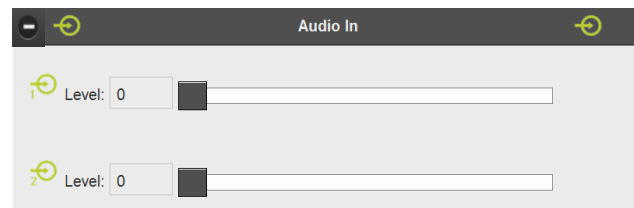

- **Audio out:**

Refer to chapter **Error! Reference source not found.:** udio out

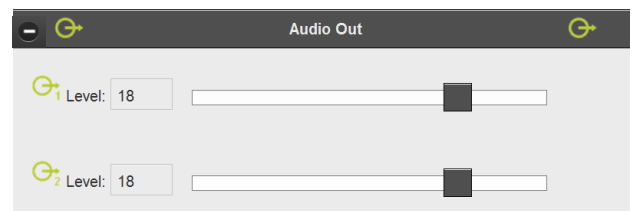

**The following settings can be accessed only on the webbrowser itself.**

- **Record Settings:**

The encoding format and filename prefix can be changed in the record settings.

1 minute of recording in WAV format takes about 4MB.

1 minute of recording in MP3 format at 192kbps takes about 1.5MB.

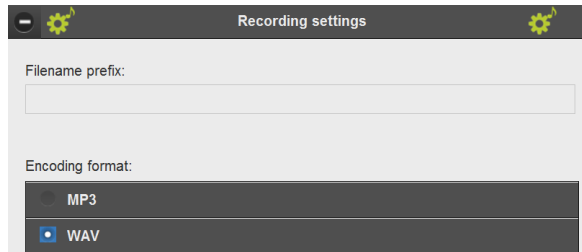

- **Camera protocol:**

The "IP address" is the destination IP address (UDP) and "Port" is the destination port (UDP). For more information about the camera protocol string we refer to chapter 16.

- **Network settings:**

You can customize the TCP/IP setting to allow the D-Cerno central unit into your personal or company LAN network. When using multiple D-Cerno central units it is mandatory to choose different IP's to prevent conflicts. After clicking "Apply" you need to restart the Central Unit by clicking the ON/OFF button and also change the IP address in your browser to the new IP address.

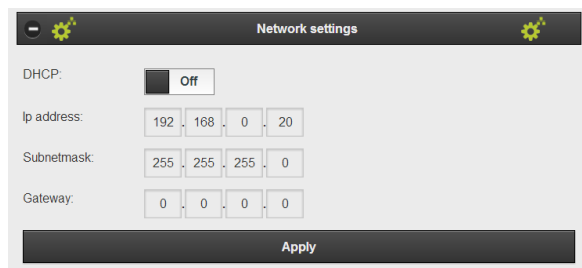

- **Language setting:**

In the language setting you can select your preferred language to view the D-Cerno webbrowser.

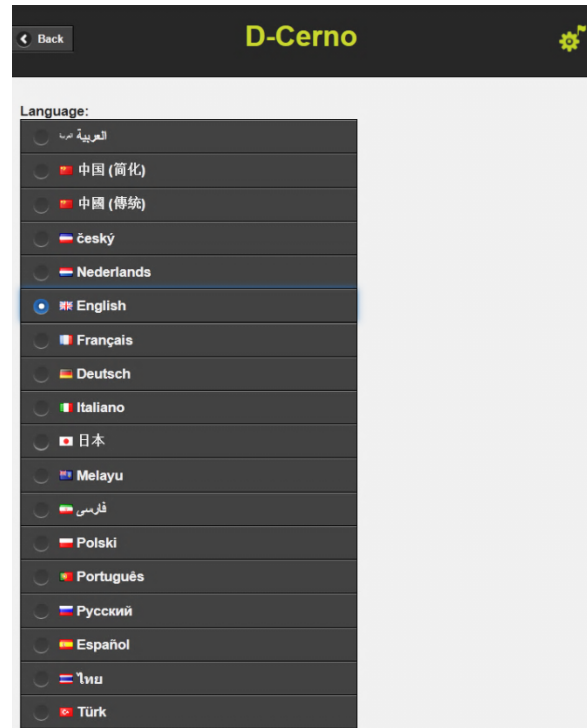

- **Change password:**

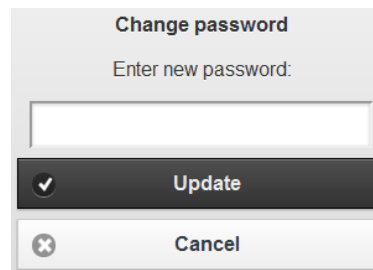

The default password "1234" can be changed to a password of your choice.

- **Time & date settings**

In the time and date settings the clock of the pc is shown. So this is not the clock that is on the D-Cerno CUR. If the timestamp that is added to the recorded files is not correct you can change that time and date by clicking "Change date and time settings...". This way you have the correct timestamp again.

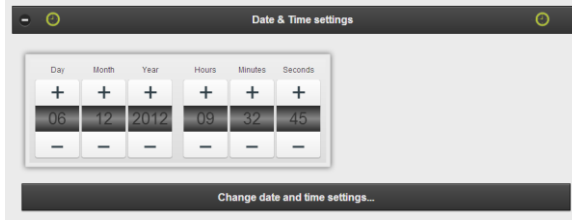

#### - System update

Here an update of the system can be performed.  
For a detailed description of the update procedure please refer to chapter 15.

#### - Info

Refer to chapter **Error! Reference source not found.**  
**Error! Reference source not found.:**  
System info

### Info

Type: D-Cerno CU-R  
Software version: 00.01  
Hardware version: 03.01  
Serial n°: 0x00900020  
Ethernet MAC: 12:34:56:78:9A:BC

### About

D-Cerno is Televic's digital discussion system for small to medium-sized conference applications. Amongst other systems on the market it stands out through its digital technology, its stylish design and its ease of use.







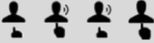

The D-Cerno CU-R is the exclusive central unit for the D-Cerno system and comes with an integrated USB recording module and web server.

A unified user interface system is used to make it cross-platform & cross-device.

## **Section 6 – Appendix**



## 14. Default Settings

Menu Item	Default Value	
Operating Mode		Direct Access
Activation mode		Toggle
Pencil drop		On
Sensitivity		
Release time		4 seconds
Microphone preset		Far (Maximum sensitivity)
Maximum number of open microphones		4
Eco mode		On
Headphone Volume		-6dBFS
Chime		Off
Loudspeaker Volume	-6dBFS	
Output level Aux Out 1	-10 dBFS	

Output level Aux Out 2	-10 dBFS	
Input level Aux In 1	OFF	
Input level Aux In 2	OFF	
Aux-In/Out Mode		Independent



## 15. System update procedure

If an update of the system is advised you will need 4 files for the 4 parts of the update: `host_x-xx-xx.mcs`, `peripheral_x-xx-xx.mcs`, `web_x-xx-xx.img` and `os_x-xx-xx.ubi`, where the `x-xx-xx` is replaced by the current version.

The latest version is available for download from the partner-domain. The complete update procedure takes about 20 minutes.



### Note:

After each part of the update, please do a restart of the Central Unit to make sure it starts with the latest uploaded version. Also close and re-open the web browser.



### Note:

If an update is done, please do an update of all files. By doing this you are 100% sure all files are up to date.

1. Firmware CU: By clicking on “Choose file” a pop-up window appears. Please choose the file “`host_x-xx-xx.mcs`”. Then press “Upload”.

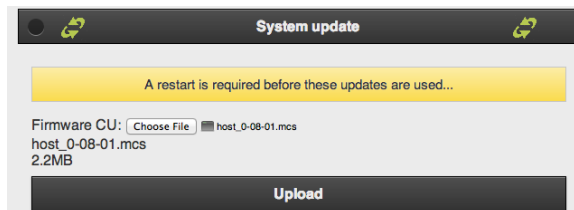

Then the following is shown:

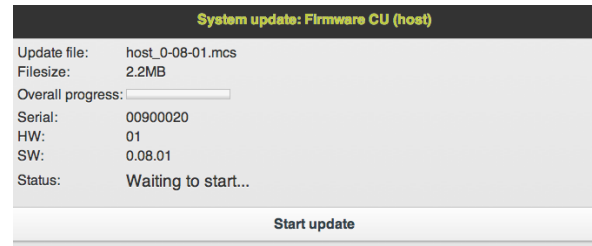

Press “Start update” to start the update. This takes around 15 minutes to complete the first parts. Under “Status”: you see the current status. When completed the status changes to “Update completed successfully!”. Then press “Back” to go to the second part and restart the central unit.

2. Firmware units: Before uploading a new file, please manually restart the central unit and re-open the web browser. Then choose the file: “`peripheral_x-xx-xx.mcs`” and click “Upload”.

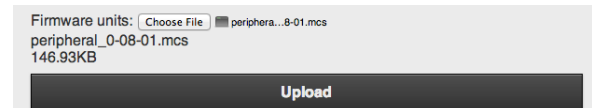

Then again a new screen is shown where the status says “Waiting to start...”. Press “Start update”. The update takes a couple of minutes. During the update the light ring of the delegate units should blink and after completion the total number of update units should correspond with the actual number of units connected to the central unit. If this is not the case it is advised to do the same update procedure a second time. (Again restart both Central Unit and web browser).

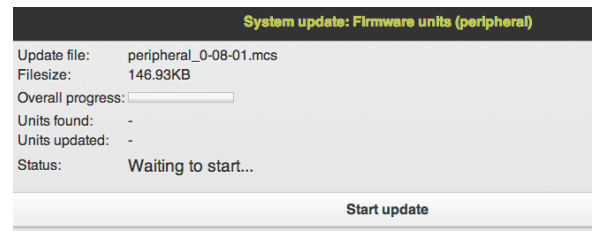

3. Webpages: Choose the file “`web_x-xx-xx.ubi`” and press “Upload”, “Start update”. The update takes about 1 minute. After completion please restart both webserver and central unit.

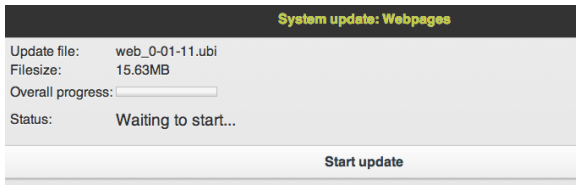

4. OS: Choose the file “os\_x-xx-xx.img” and press “Upload”, “Start update”. The update takes about 1 minute. After completion please restart both webserver and central unit.

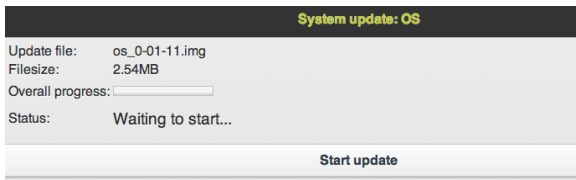

Now all files and units are up to date.

## 16. Camera protocol

First set the correct destination IP address and port. The port number has to be higher than 3000. For example 9050 is a valid port.

The content is sent using the UDP packet protocol and it is given in the following format (the \* are substitute for the real values, see further examples):

```
{"serial": "*****", "status": *, "totalMicOn":
*, "totalMicReq", *}
```

“serial” contains the serial code of the delegate unit. This code is shown at the back of each delegate unit, as the 8-digit number just under the barcode.

The “serial” data of a D-Cerno D delegate unit starts with “10.....”

The “serial” data of a D-Cerno C chairman unit starts with “11.....”



“status” has several options:

0 = off

1 = on

2 = request

4 = next in line

8 = prior

“totalMicOn” = total number of active microphones.

“totalMicReq” = total number of microphones in request.

So for example if the microphone with serial “101008D2” goes into request mode the following command is send:

```
{"serial": "101008D2", "status": 2, "totalMicOn":
1, "totalMicReq", 0}
```

After a microphone conference mode change the following string is sent:

```
{"serial": "00000000", "status": 0, "totalMicOn":
0, "totalMicReq", 0}
```

## 17. D-Cerno CUR startup options

The D-Cerno CUR has two startup triggers:

- On / Off button
- Connection with the power supply

This choice can be made by setting a hardware switch in a certain position. The default trigger is the On / Off button. To change this to automatic startup when the power supply is connected, please follow the following steps:

- Make sure nothing is plugged in in the D-Cerno CUR.
- Remove the screws at the back of the units as shown below.



- Carefully remove the front of the unit. The location of the switch is marked in red below.



- Below a close-up of the switch. The startup option is the lower switch. By default (On / Off switch mode) the switch is positioned to the left. To change the mode to start from the moment to power is supplied to the unit the switch needs to be positioned to the right, as shown in the picture below.

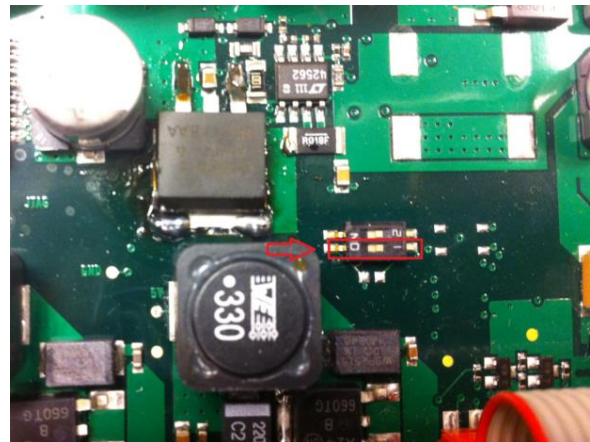

- Carefully reassemble the unit.



**Note:**

Before switching on the central unit please make sure all units are correctly connected to the Central Unit.

## 18. Technical Data

### 18.1. Electrical and Electro Acoustical Characteristics

Frequency response	25Hz to 15 KHz (+/-3dB)
Harmonic distortion	≤ 0.02%
Input sensitivity	0dBV= -10dBFS
Input gain adjustment	+24dB to -51dB + "OFF"
Input impedance Aux 1	≥ 7 KΩ (asymm.)
Input impedance Aux2	≥ 20 KΩ (symm.)
Output level	0dBV= -10dBFS
Output gain adjustment	+24dB to -51dB + "OFF"
Output impedance	≤ 600 Ω
Volume control	0dB to -46dB + "OFF"
Headphone output level	Max 70mW in 32 Ω
Headphone volume control	0dB to -72dB + "OFF"
Headphone impedance =	16 Ω to 150 Ω

### 18.2. Mechanical Characteristics

#### Dimensions W x H x D (mm)

Central unit:	300 x 135 x 50
Including Packing:	345 x 250 x 155
Delegate / Chairman unit:	210 x 135 x 50

Including Packing: 335 x 250 x 120

Power supply: 170 x 70 x 35

Including Packing: 215 x 160 x 50

#### Weight (g)

Central unit: 1300

Including packing (CU + PS + Cable) 2660

Delegate / Chairman unit: 660

Including packing (unit + cable) 1100

Power supply: 920

### 18.3. Environmental Characteristics

Temperature 5°C to 50°C

Humidity Protection class EP10  
Compliant to IEC 60068\_2.14

### 18.4. System limits

Max units on CU 50

Max units on one port 25

Maximum cable length (branch or loop) 400 m

Maximum cable length between units or between CU and first unit 80m

### 18.5. Webbrowser

Default IP address 192.168.0.20

Default subnet mask 255.255.255.0

Default password 1234

## 18.6. USB specs

File system	FAT
USB type	USB 2.0
Device type	Mass storage



For more information visit:  
[www.televic-conference.com](http://www.televic-conference.com)

Data subject to change without notice