

SM 3

SPEEDMOUNT COMPACT FULL-RANGE SURFACE MOUNT SPEAKERS

SPEED MOUNT

- ▶ Patented, concealed mounting system
- ▶ Included 0° and 10° mounting plates provide flexible installation options
- ▶ Designed to accommodate division-of-labor installations
- ▶ 8 ohm nominal impedance
- ▶ 3" (7.6 cm) full-range driver with a tuned bass reflex port
- ▶ Frequency range: 100 Hz to 20 kHz
- ▶ 15 watts continuous pink noise, 30 watts continuous program
- ▶ Complies with ADA requirements on protrusion limits
- ▶ Hidden locking speaker release mechanism
- ▶ Black or white high-impact enclosure
- ▶ 5 year parts and labor warranty



The Extron SM 3 is a compact, full-range surface mount speaker featuring an innovative wall mounting system. The SM 3 delivers wide room coverage and a wide frequency range for accurate voice and music reproduction. This speaker is ideally suited for small to medium classrooms and conference rooms, and is designed for fast installation with the Extron-exclusive, concealed mounting system.



Extron Electronics
INTERFACING, SWITCHING AND CONTROL

DESCRIPTION

The Extron **SM 3** SpeedMount® Surface Mount Speaker is a compact full-range speaker with a patented, concealed wall mounting system. The enclosure measures less than 4" (10.2 cm) deep. The 8 ohm speaker features a 3" (7.6 cm) full-range driver and tuned bass port, a wide frequency range of 100 Hz to 20 kHz, and a power rating of 15 watts continuous pink noise, 30 watts continuous program capacity. The Extron-exclusive mounting system is designed to accommodate division-of-labor installations and save costs.

The innovative mounting system allows the SM 3 to slide onto the mount and lock into place. In the same installation step, the integrated electrical contacts on the speaker automatically mate with the pre-wired contacts on the mounting plate to speed up and simplify installation.

The SM 3 saves time and installation costs for AV system contractors working with low-voltage contractors in a division-of-labor installation. During rough-in, a low-voltage contractor installs the mounting system on the wall and terminates the speaker cable to the mount's integrated wiring contacts. Later, the AV system contractor completes the installation by sliding the SM 3 speaker onto the mount.

KEY FEATURES

- ▶ **Patented, concealed mounting system** – One installation step connects the speaker to the wiring contacts, and secures it into place.
- ▶ **Includes 0° and 10° mounting plates**
- ▶ **Designed to accommodate division-of-labor installations and save costs**
- ▶ **8 ohm nominal impedance**
- ▶ **3" (7.6 cm) full-range driver with a tuned bass reflex port**
- ▶ **Frequency range: 100 Hz to 20 kHz**
- ▶ **15 watts continuous pink noise, 30 watts continuous program**
- ▶ **Flush mount design with shallow profile**
- ▶ **Complies with ADA requirements on protrusion limits when used with 0° mounting plate**
- ▶ **Hidden locking speaker release mechanism**
- ▶ **Mounting plates provide cable raceway access for surface-mounted wiring applications**
- ▶ **Black or white high-impact enclosure**
- ▶ **Dimensions with 0° mounting plate:**
8.75" H x 5.75" W x 4.0" D
(22.2 cm H x 14.6 cm W x 10.2 cm D)
- ▶ **5 year parts and labor warranty**

SPECIFICATIONS

AUDIO/ACOUSTIC AND ELECTRICAL		
Speaker type	1-way, full range, indoor surface mount speaker	
Frequency range	100 Hz to 20 kHz, -10 dB, full space	
Power capacity	15 W (rms) continuous pink noise (per IEC 60268-5) 30 W (rms) continuous program	
Nominal sensitivity	83 dB SPL, 1 W, 1 m, full space	
Nominal coverage angles	Horizontal: 120° (1 kHz - 4 kHz, weighted 2 kHz - 4kHz) Vertical: 130° (1 kHz - 4 kHz, weighted 2 kHz - 4kHz)	
Nominal impedance	8 ohms	
Driver	(1) 3" (76.2 mm) paper cone	
Input connectors	Speaker 2 recessed pins Mounting plate (1) 10 mm Euro-style captive screw terminal block, 2 pole	
GENERAL		
Package	2 speakers (1 pair) with mounting kit	
Temperature/humidity	Storage: -40 to +158 °F (-40 to +70 °C) / 10% to 90%, noncondensing Operating: +32 to +122 °F (0 to +50 °C) / 10% to 90%, noncondensing	
Mounting	Wall mountable with included mounting plates (0° and 10°) NOTE: Speaker mounting angle is fixed at 0° or 10° from vertical based on the mounting plate used.	
Enclosure type	Plastic, trapezoidal, with molded grille and front bass reflex port	
Enclosure outer dimensions	With 0° mounting plate 8.75" H x 5.75" W x 4.0" D (22.2 cm H x 14.6 cm W x 10.2 cm D) With 10° mounting plate 8.9" H x 5.75" W x 5.0" D (22.6 cm H x 14.6 cm W x 12.7 cm D)	
Product weight	Single: 2.0 lbs (0.9 kg)	
Regulatory compliance	CE	
Safety	Complies with the appropriate requirements of RoHS, WEEE.	
Environmental		
Warranty	5 years parts and labor	
NOTE: All nominal levels are at ±10%.		
Model	Version Description	Part number
SM 3	SpeedMount, 3" Driver, Black, Pair	42-133-02
SM 3	SpeedMount, 3" Driver, White Pair	42-133-03

For complete specifications, please go to www.extron.com
Specifications are subject to change without notice.

APPLICATION DIAGRAM

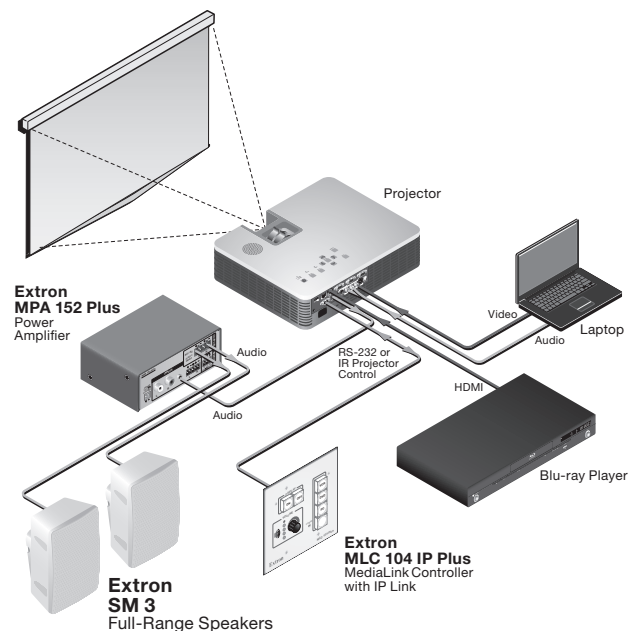

SPEEDMOUNT SPEAKER INSTALLATION

SPEED MOUNT

The unique mounting system of the SM 3 SpeedMount speaker greatly simplifies installation of surface mount speakers, and saves considerable time and cost in labor. A mounting plate is installed at a designated wall location for an SM 3. Speaker cable is terminated to wiring contacts on the plate. All that is left is to slide the speaker onto the mount. In one sliding motion, the SpeedMount speaker is positioned into place and automatically mated with the mount's wiring contacts.

STEP 1

Pull speaker wire

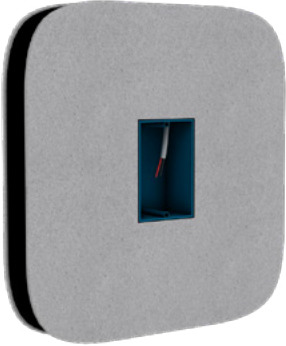

STEP 2

Attach plate to wall, stud, or electrical box and connect speaker wire to contacts on plate. The SM 3 includes 0° and 10° mounting plates.



STEP 3

Simply slide speaker onto plate. Speaker may be locked into place with a unique key.



To see an animated demonstration of SM 3 installation go to: www.extron.com/www.extron.com/sm3install

Included Mounting Plates

To meet a variety of installation needs, the flexible mounting system includes 0° and 10° mounting plates. Each mounting plate allows the SM 3 to be oriented vertically or horizontally. The speaker can be installed flush with the wall using the 0° mounting plate, or with a 10° tilt when the 10° plate is used.

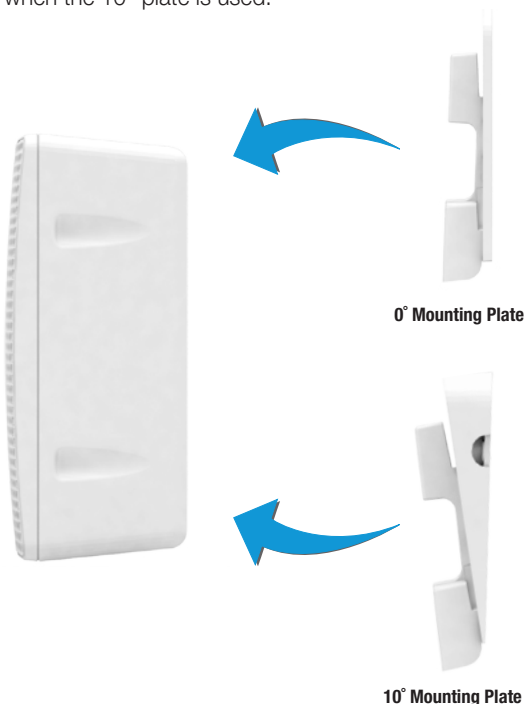

ADA-Compliant Flush Mount Design

The SM 3 has a profile of 4 inches (10 cm) when installed with the 0° mounting plate. This complies with ADA - Americans with Disabilities Act requirements on protrusion limits. According to Section 307 of the ADA Accessibility Standards, objects must not protrude more than 4 inches into the space.

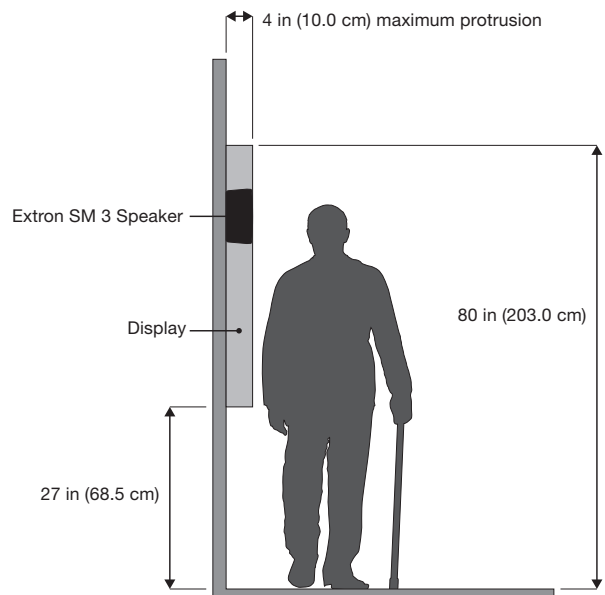

POLAR GRAPHS - 1/3 OCTAVE, HORIZONTAL

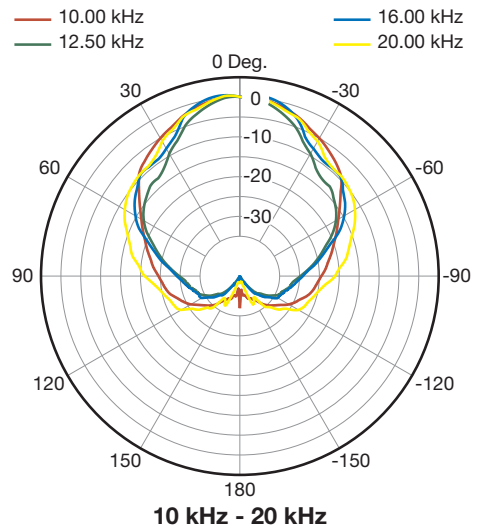
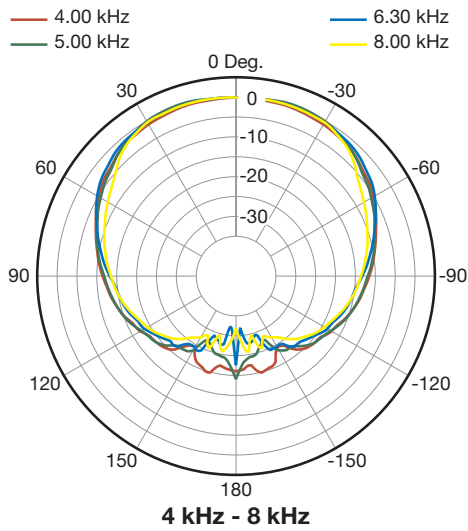
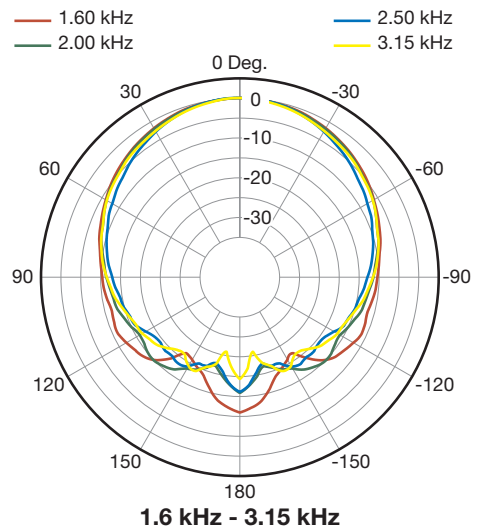
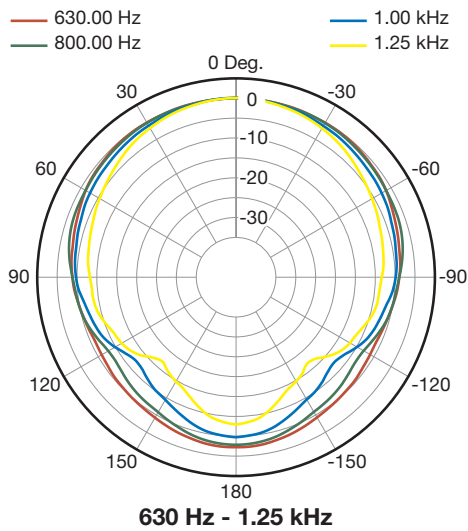
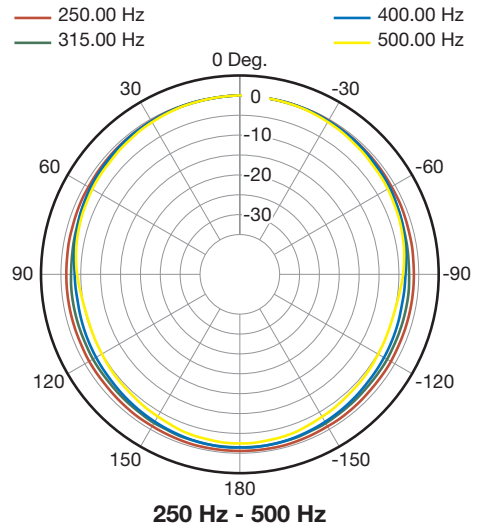
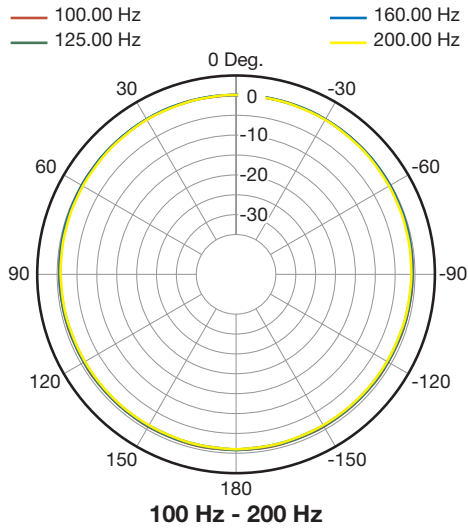

RESPONSE GRAPHS - FREQUENCY AND IMPEDANCE

SPL VS. FREQUENCY – 1 WATT @ 1 METER RESPONSE, FULL SPACE (4π)

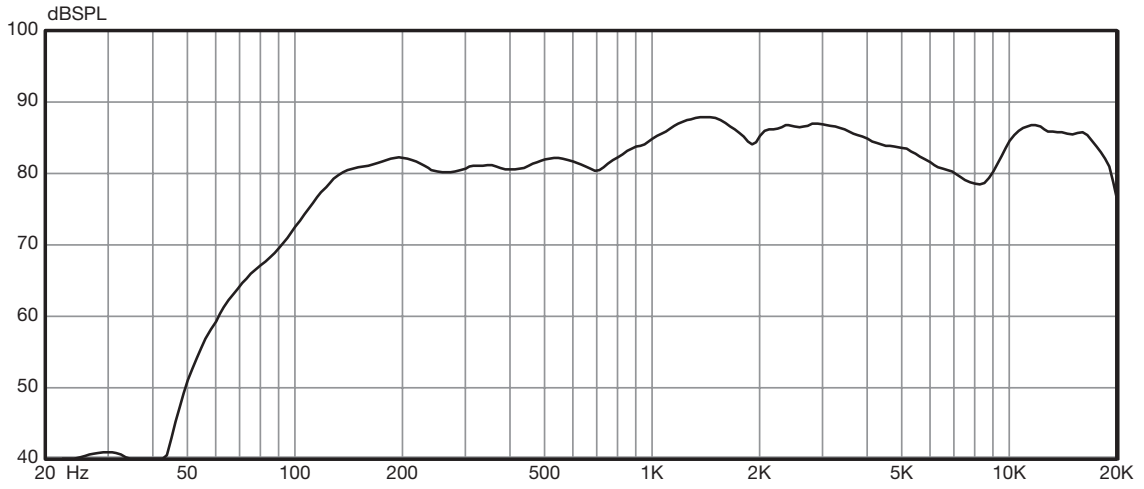

SPL VS. FREQUENCY – HORIZONTAL OFF-AXIS RESPONSE, FULL SPACE (4π)

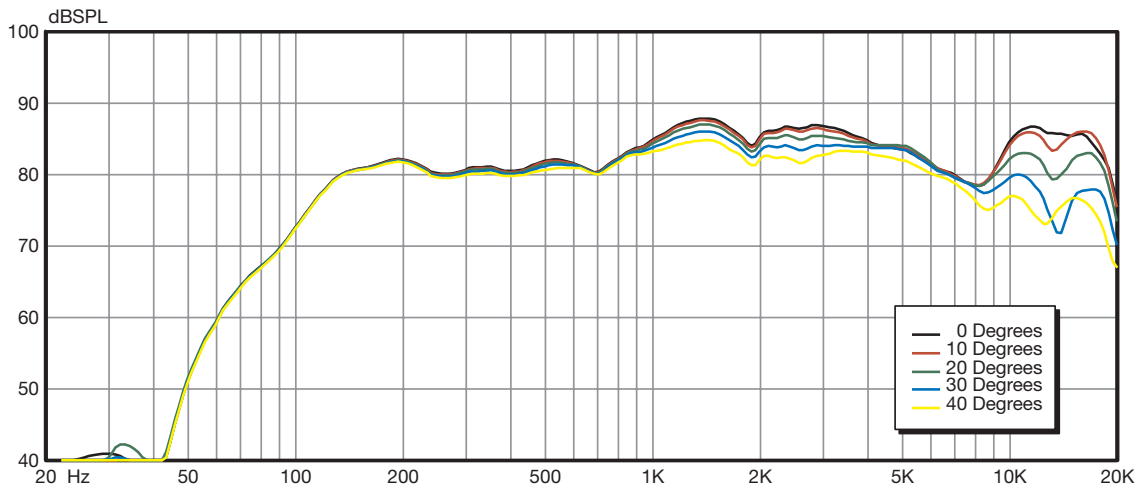

IMPEDANCE VS. FREQUENCY

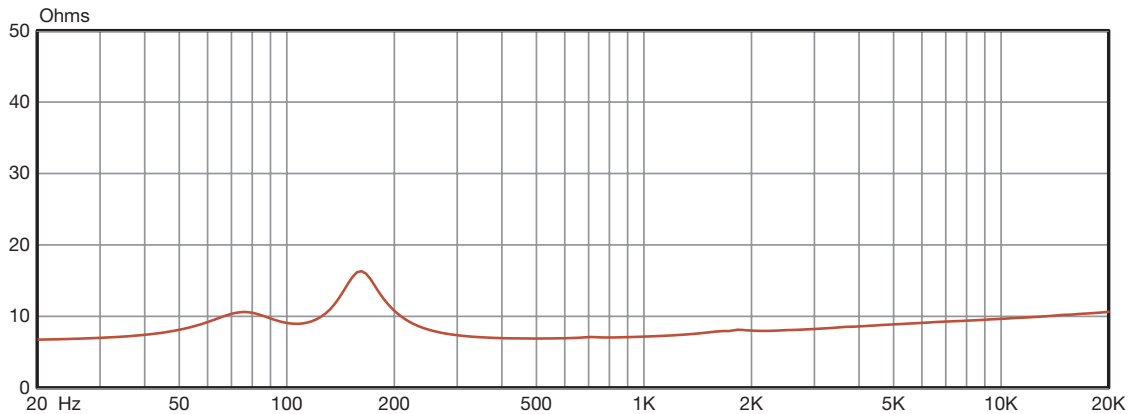

PANEL DRAWINGS

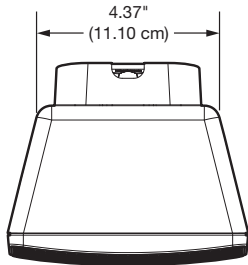

Top

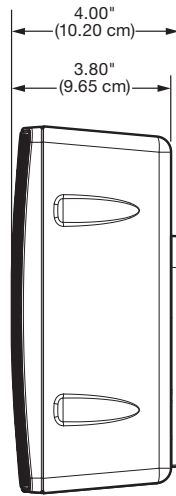

**Side View with
0 Degree Mount**

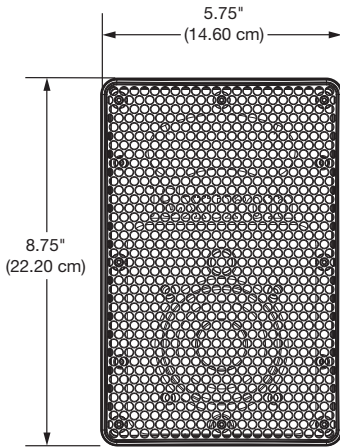
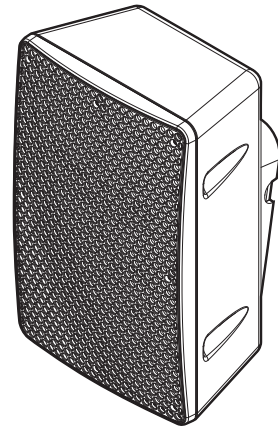

Front

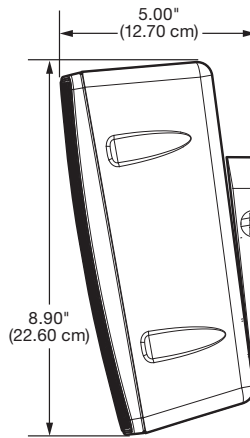

**Side View with
10 Degree Mount**

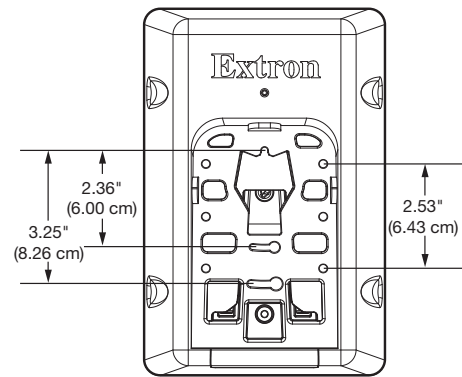

Rear

WORLDWIDE SALES OFFICES

Anaheim • Raleigh • Silicon Valley • Dallas • New York • Washington, DC • Toronto • Mexico City • Paris • London • Frankfurt
 Stockholm • Amersfoort • Moscow • Dubai • Johannesburg • Tel Aviv • Sydney • Melbourne • New Delhi • Bangalore
 Singapore • Seoul • Shanghai • Beijing • Hong Kong • Tokyo

www.extron.com