



Renkus-Heinz beam-steering technology, now in a passive column.

The UBX series from Renkus-Heinz delivers the precise coverage, high intelligibility, and renowned sound quality of their flagship Iconyx loudspeakers into the realm of passive column arrays. New for the UBX Series is our Passive UniBeam Technology™ which addresses each transducer with specially designed all-pass filter networks, gain shading, and additional frequency filtering in order to generate an asymmetrical vertical dispersion with constant directivity, delivering consistent front-to-back coverage with minimal side lobe artifacts.

The UBX Series utilizes state of the art neodymium 3" Full-Range drivers which allow for an incredibly small footprint. The narrow cabinet, combined with Passive UniBeam coverage, allows for plumb surface mounting via the included wall mount bracket, resulting in the least possible architectural intrusion. All models in the UBX Series are weather resistant (IP64) out of the box with the included gland/conduit knock-out input cover, and feature high-quality audio transformers for 70V/100V constant voltage operation in large, distributed audio systems.

Applications

- EN54-24 Certification make the UBX4 ideal for Voice Alarm applications.
- The UBX4's small size and consistent vertical coverage make it the ideal loudspeaker for K-12 classrooms.
- Inherent IP64 weather resistance and discreet size make the UBX4 ideal for outdoor distributed audio systems in places like theme parks.
- Tight vertical dispersion constant directivity deliver excellent performance for delay or balcony fill loudspeaker for larger systems.

UBX4

The UBX4 is the smallest model in the UBX Series, but it still delivers an unmatched combination of features for a loudspeaker of its size. Passive UniBeam Technology™ offers incredibly consistent coverage and constant directivity for such a small loudspeaker. Four high-quality neodymium transducers deliver the impeccable sound quality Renkus-Heinz audio solutions are known for. The included 60W 70/100V transformer, wall-mount bracket and standard weather resistance make it simple to integrate into any system design.

UBX Series

UBX4

Non-Powered Column Array with Passive UniBeam™ Technology



- **Passive UniBeam Technology™**

Asymmetrical vertical dispersion, constant directivity, and inherent down-angle deliver incredible coverage even when mounted plumb.

- **High-Quality Audio Components**

3" Neodymium full-range drivers, crossover components, and transformers were all selected for impeccable audio performance.

- **Out-of-the-Box Simplicity**

Included panable wall-mount bracket and inherent weather resistance means the UBX4 is ready to go out of the box.

UBX4 Specifications

Frequency Response:	150 Hz to 15 kHz (-3 dB) ¹ 115 Hz to 18 kHz (-10 dB) ¹
Sensitivity:	91 dB (1 W / 1 m) ¹ 77 dB (4 m, per EN54-24) ²
Impedance:	12 Ohms
Power Handling:	30 W (100 Hr, per EN54-24) 55 W (AES) 110 W (PGM) 220 W (PEAK)
Transformer:	70/100V Transformer 70 V - 8 W (800 Ω), 15 W (400 Ω), 30 W (200 Ω), 60 W (100 Ω) Taps 100 V - 15 W (800 Ω), 30 W (400 Ω), 60 W (200 Ω) Taps
Maximum SPL:	114 dB Peak @ 1 m ¹ 92 dB @ 4 m (through transformer, per EN54-24) ²
Dispersion H:	120° horizontal below 5 kHz, 90° above 5 kHz ¹
Dispersion V:	30° asymmetrical (+10°/-20°) with 7° average down-tilt above 2.5 kHz ¹
Coverage Angles:	500 Hz: 360 H x 125 V 1000 Hz: 200 H x 80 V 2000 Hz: 124 H x 43 V 4000 Hz: 154 H x 21 V
Transducers:	4 x 3 in/77 mm, full-range, high-sensitivity, treated-paper cone driver
Connector:	Covered screw terminals
Enclosure:	Extruded aluminum
Grille:	Perforated, bent aluminum
Finish:	Black (RAL9011) or White (RAL9010) paint
Weather Rating:	IP64 with salt spray, chlorine, and UV resistance
Certifications:	EN54-24
Operating Temperature:	Minimum: -22° F / -30° C Maximum: 140° F / 60° C with no direct sun exposure
Mounting:	W-WALL-UBX Surface-mount pan bracket (included) W-WALL-UBX-PT pan/tilt bracket (optional)
Dimensions:	4-3/8" (111.4 mm) w 17-1/8" (435 mm) h 4-3/4" (120.7 mm) d
Weight:	10.2 lbs (4.6 kg)

Notes:

1. Standard acoustic measurements taken on axis.

2. EN54 ratings measured at 6 degrees down from 'on axis', reference point of 'On Axis' is the center of the driver array with loudspeaker mounted vertically.

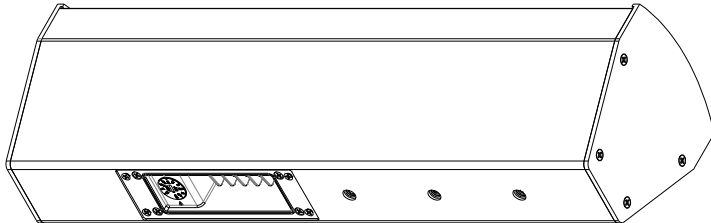
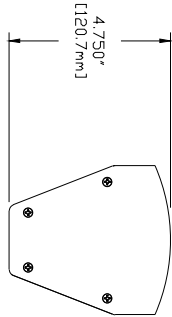
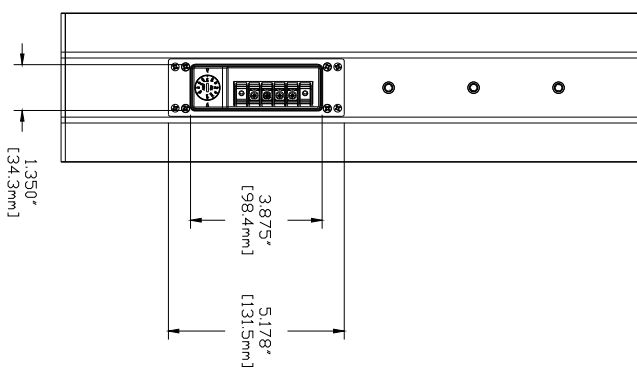
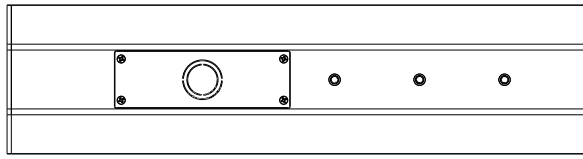
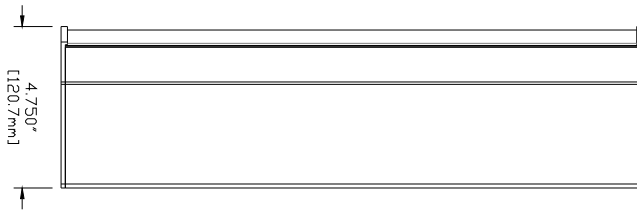
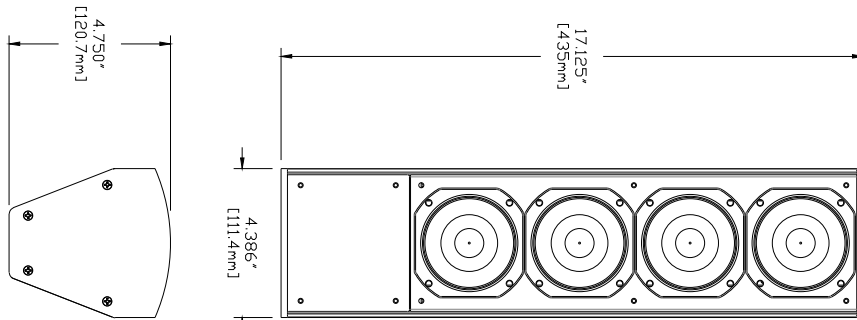

Measurements

1m on-axis Frequency Response

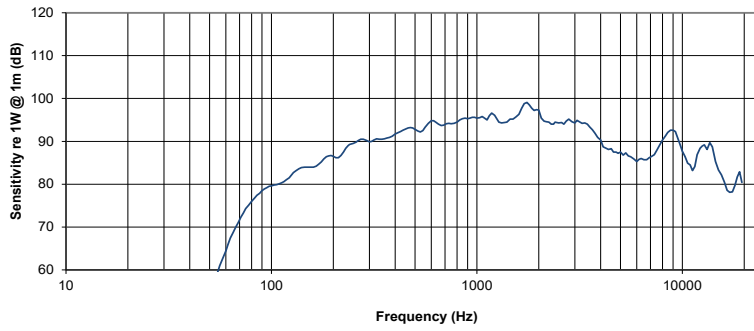

Impedance vs frequency

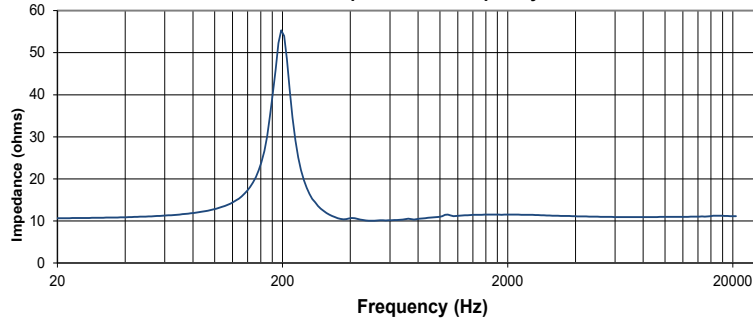

Beamwidth vs Frequency (@ 5m/16.4ft)

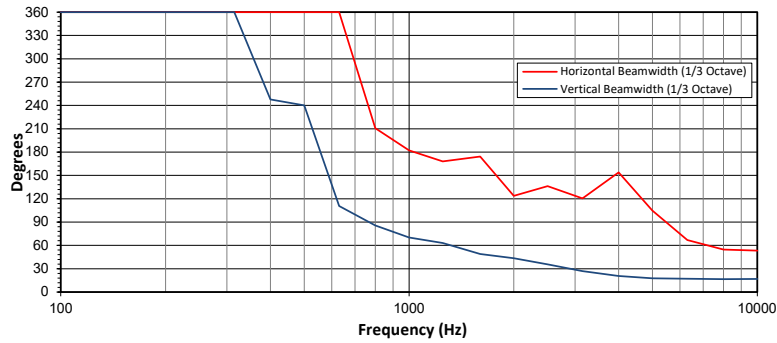

DI vs Frequency (@ 5m/16.4ft)

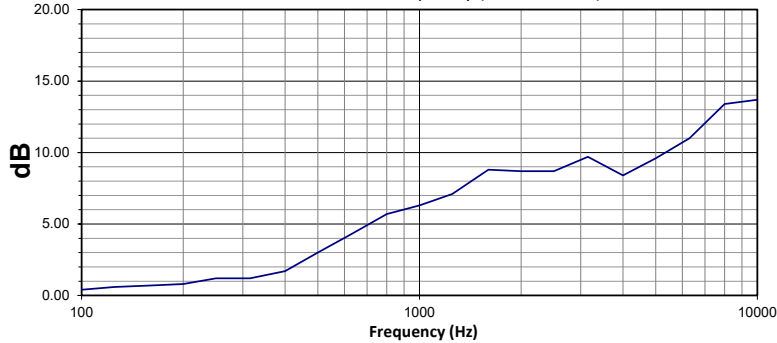

Measurements continued

Horizontal Off-axis Frequency Response, Normalized On-Axis

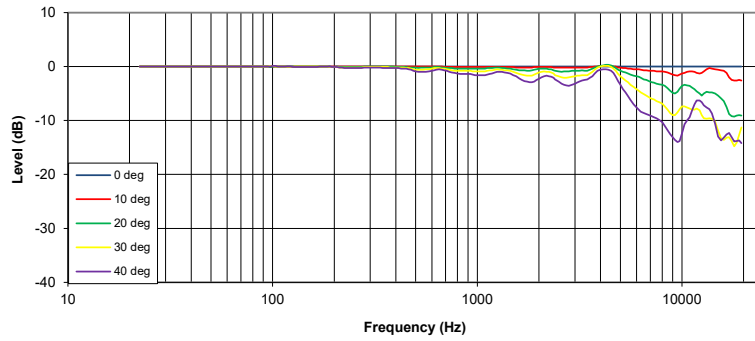

Lower Vertical Off-axis Frequency Response, Normalized On-Axis

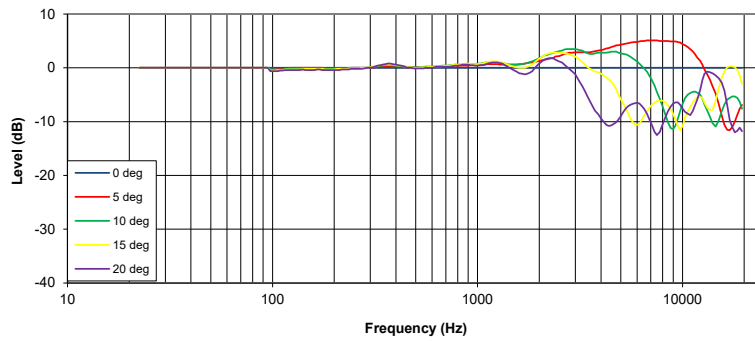

Upper Vertical Off-axis Frequency Response, Normalized On-Axis

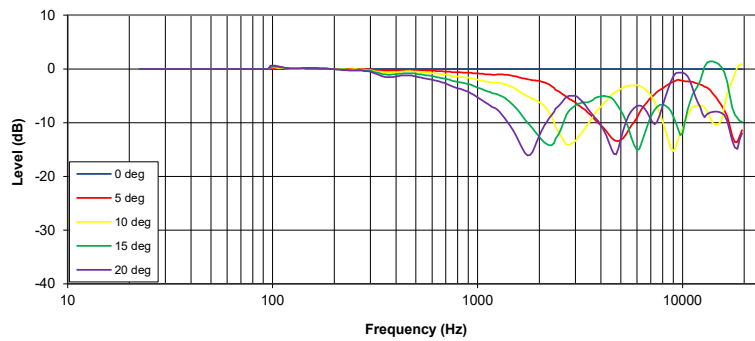

Measurements continued

250 Hz 1/3 Oct

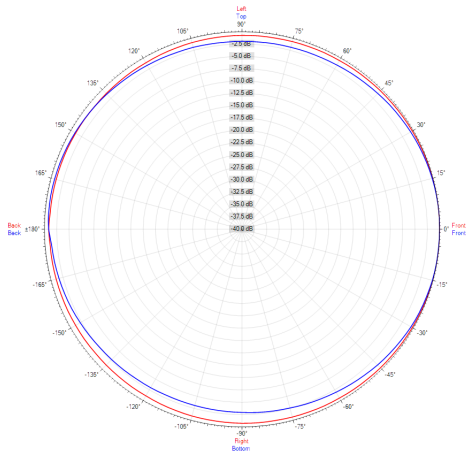

500 Hz 1/3 Oct

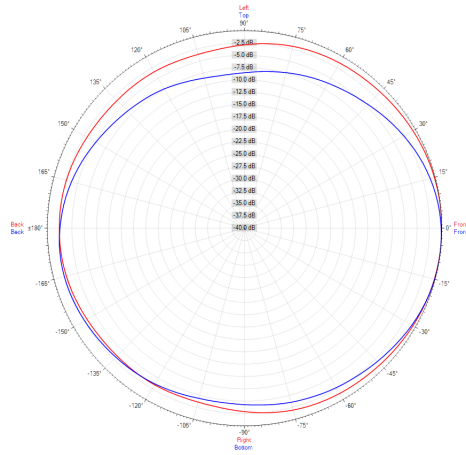

1 kHz 1/3 Oct

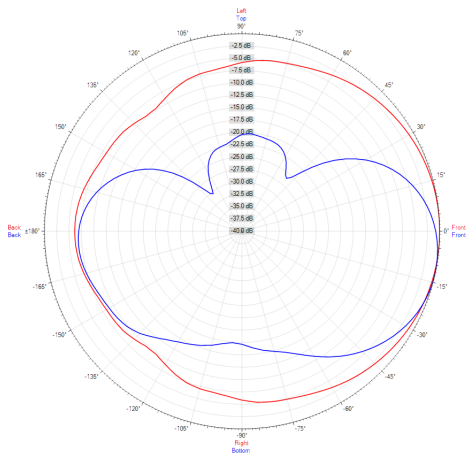

2 kHz 1/3 Oct

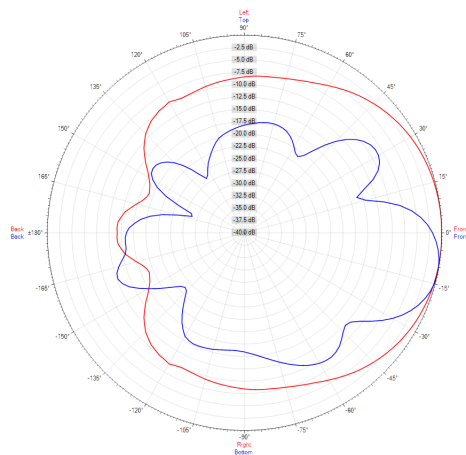

4 kHz 1/3 Oct

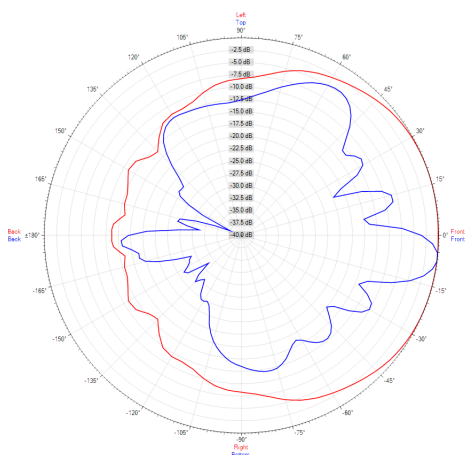

8 kHz 1/3 Oct

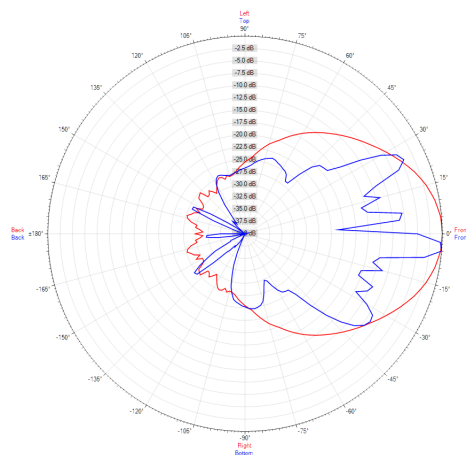

This page is intentionally blank.

This page is intentionally blank.